

D01157920A

TASCAM

DR-40

Linear PCM Recorder

This device has a serial number located on the bottom panel. Please record it and retain it for your records.

Serial number:

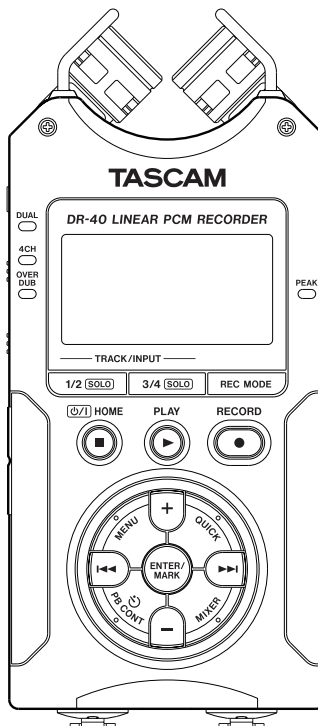

OWNER'S MANUAL

IMPORTANT SAFETY PRECAUTIONS

Declaration of Conformity

Model Number: DR-40
Trade Name: TASCAM
Responsible party: TEAC AMERICA, INC.
Address: 7733 Telegraph Road, Montebello,
California, U.S. A.
Telephone number: 1-323-726-0303

This device complies with Part 15 of the FCC Rules. Operation is subject to the following two conditions: (1) this device may not cause harmful interference, and (2) this device must accept any interference received, including interference that may cause undesired operation.

THIS CLASS B DIGITAL APPARATUS COMPLIES WITH CANADIAN ICES-003.
CET APPAREIL NUMÉRIQUE DE LA CLASSE B EST CONFORME À LA NORME
NMB-003 DU CANADA.

FOR U.S.A.

TO THE USER

This equipment has been tested and found to comply with the limits for a Class B digital device, pursuant to Part 15 of the FCC Rules. These limits are designed to provide reasonable protection against harmful interference in a residential installation. This equipment generates, uses, and can radiate radio frequency energy and, if not installed and used in accordance with the instruction manual, may cause harmful interference to radio communications. However, there is no guarantee that interference will not occur in a particular installation. If this equipment does cause harmful interference to radio or television reception, which can be determined by turning the equipment off and on, the user is encouraged to try to correct the interference by one or more of the following measures.

- a) Reorient or relocate the receiving antenna.
- b) Increase the separation between the equipment and receiver.
- c) Connect the equipment into an outlet on a circuit different from that to which the receiver is connected.
- d) Consult the dealer or an experienced radio/TV technician for help.

CAUTION

Changes or modifications to this equipment not expressly approved by TEAC CORPORATION for compliance could void the user's authority to operate this equipment.

IMPORTANT SAFETY INSTRUCTIONS

- 1 Read these instructions.
- 2 Keep these instructions.
- 3 Heed all warnings.
- 4 Follow all instructions.
- 5 Do not use this apparatus near water.
- 6 Clean only with dry cloth.
- 7 Do not block any ventilation openings. Install in accordance with the manufacturer's instructions.
- 8 Do not install near any heat sources such as radiators, heat registers, stoves, or other apparatus (including amplifiers) that produce heat.
- 9 Do not defeat the safety purpose of the polarized or grounding-type plug. A polarized plug has two blades with one wider than the other. A grounding type plug has two blades and a third grounding prong. The wide blade or the third prong are provided for your safety. If the provided plug does not fit into your outlet, consult an electrician for replacement of the obsolete outlet.
- 10 Protect the power cord from being walked on or pinched particularly at plugs, convenience receptacles, and the point where they exit from the apparatus.
- 11 Only use attachments/accessories specified by the manufacturer.
- 12 Use only with the cart, stand, tripod, bracket, or table specified by the manufacturer, or sold with the apparatus. When a cart is used, use caution when moving the cart/apparatus combination to avoid injury from tip-over.



- 13 Unplug this apparatus during lightning storms or when unused for long periods of time.
- 14 Refer all servicing to qualified service personnel. Servicing is required when the apparatus has been damaged in any way, such as power-supply cord

or plug is damaged, liquid has been spilled or objects have fallen into the apparatus, the apparatus has been exposed to rain or moisture, does not operate normally, or has been dropped.

- Do not expose this apparatus to drips or splashes.
- Do not place any objects filled with liquids, such as vases, on the apparatus.
- Do not install this apparatus in a confined space such as a book case or similar unit.
- The apparatus draws nominal non-operating power from the AC outlet with its POWER or STANDBY/ON switch not in the ON position.
- The apparatus should be located close enough to the AC outlet so that you can easily grasp the power cord plug at any time.
- The mains plug is used as the disconnect device, the disconnect device shall remain readily operable.
- If the product uses batteries (including a battery pack or installed batteries), they should not be exposed to sunshine, fire or excessive heat.
- CAUTION for products that use replaceable lithium batteries: there is danger of explosion if a battery is replaced with an incorrect type of battery. Replace only with the same or equivalent type.
- Caution should be taken when using earphones or headphones with the product because excessive sound pressure (volume) from earphones or headphones can cause hearing loss.

Safety Information

■ Cautions about Batteries

This product uses batteries. Misuse of batteries could cause a leak, rupture or other trouble. Always abide by the following precautions when using batteries.

- Never recharge non-rechargeable batteries. The batteries could rupture or leak, causing fire or injury.
- When installing batteries, pay attention to the polarity indications (plus/minus (+/-) orientation), and install them correctly in the battery compartment as indicated. Putting them in backward could make the batteries rupture or leak, causing fire, injury or stains around them.
- When you store or dispose of batteries, isolate their terminals with insulation tape or something like that to prevent them from contacting other batteries or metallic objects.
- When throwing used batteries away, follow the disposal instructions indicated on the batteries and the local disposal laws.
- Do not use batteries other than those specified. Do not mix and use new and old batteries or different types of batteries together. The batteries could rupture or leak, causing fire, injury or stains around them.
- Do not carry or store batteries together with small metal objects. The batteries could short, causing leak, rupture or other trouble.
- Do not heat or disassemble batteries. Do not put them in fire or water. Batteries could rupture or leak, causing fire, injury or stains around them.
- If the battery fluid leaks, wipe away any fluid on the battery case before inserting new batteries. If the battery fluid gets in an eye, it could cause loss of eyesight. If fluid does enter an eye, wash it out thoroughly with clean water without rubbing the eye and then consult a doctor immediately. If the fluid gets on a person's body or clothing, it could cause skin injuries or burns. If this should happen, wash it off with clean water and then consult a doctor immediately.
- The unit power should be off when you install and replace batteries.

- Remove the batteries if you do not plan to use the unit for a long time. Batteries could rupture or leak, causing fire, injury or stains around them. If the battery fluid leaks, wipe away any fluid on the battery compartment before inserting new batteries.

■ For European Customers

Disposal of electrical and electronic equipment

- (a) All electrical and electronic equipment should be disposed of separately from the municipal waste stream via designated collection facilities appointed by the government or the local authorities.
- (b) By disposing of the electrical and electronic equipment correctly, you will help save valuable resources and prevent any potential negative effects on human health and the environment.
- (c) Improper disposal of waste equipment can have serious effects on the environment and human health as a result of the presence of hazardous substances in electrical and electronic equipment.
- (d) The crossed out wheeled dust bin symbol indicates that electrical and electronic equipment must be collected and disposed of separately from household waste.



- (e) The return and collection systems are available to the end users. For more detailed information about disposal of old electrical and electronic equipment, please contact your city office, waste disposal service or the shop where you purchased the equipment.

Disposal of batteries and/or accumulators

- (a) Waste batteries and/or accumulators should be disposed of separately from the municipal waste stream via designated collection facilities appointed by the government or the local authorities.
- (b) By disposing of waste batteries and/or accumulators correctly, you will help save valuable resources and prevent any potential negative effects on human health and the environment.
- (c) Improper disposal of waste batteries and/or accumulators can have serious effects on the environment and human health as a result of the presence of hazardous substances in batteries and/or accumulators.
- (d) The crossed out wheeled dust bin symbol indicates that batteries and/or accumulators must be collected and disposed of separately from household waste.



Pb, Hg, Cd

If the battery or accumulator contains more than the specified values of lead (Pb), mercury (Hg), and/or cadmium (Cd) defined in the Battery Directive (2006/66/EC), then the chemical symbols for lead (Pb), mercury (Hg) and/or cadmium (Cd) will be indicated beneath the crossed out wheeled dust bin symbol.

- (e) The return and collection systems are available to the end users. For more detailed information about disposal of waste batteries and/or accumulators, please contact your city office, waste disposal service or the shop where you purchased them.

产品有毒有害物质或元素的名称及含量

机种：DR-40		有毒有害物质或元素					
	品名	铅 (Pb)	汞 (Hg)	镉 (Cd)	六价铬 (Cr (VI))	多溴联苯 (PBB)	多溴二苯醚 (PBDE)
1	CHASSIS部份	×	○	○	○	○	○
2	PCB Assy部份	×	○	○	○	○	○
3	线材部份	○	○	○	○	○	○
4	附属品部份	×	○	○	○	○	○
5	SEAL部份	○	○	○	○	○	○
6	包装部份	○	○	○	○	○	○

○：表示该有毒有害物质在该部件所有均质材料中的含量均在 SJ/T11363-2006 标准规定的限量要求以下。

×：表示该有毒有害物质至少在该部件的某一均质材料中的含量超出 SJ/T11363-2006 标准规定的限量要求。

(针对现在代替技术困难的电子部品及合金中的铅)

Table of Contents

IMPORTANT SAFETY PRECAUTIONS	2	Menu item list	30
IMPORTANT SAFETY INSTRUCTIONS	3	Using menus.....	31
Safety Information	4	Basic operation	32
Quick Start Guide	10	3 – Preparation.....	34
1 – Introduction	12	Powering the unit	34
Features.....	12	Using AA batteries	34
Items included with the product	14	Using an AC adaptor (sold separately)	35
Conventions used in this manual	14	Using USB bus power	35
Intellectual property rights	15	Start-up & shutdown	36
About SD cards.....	16	Starting up the unit.....	36
Precautions for use	16	Shutting down	37
Precautions for placement and use	17	Resume function	37
Beware of condensation	17	Setting the date and time.....	37
Cleaning the unit	17	Inserting and removing SD cards	38
User registration.....	17	Inserting the SD card	38
2 – Names and Functions of Parts	18	Removing the card	39
Top panel.....	18	Card write protection	39
Front panel.....	22	Preparing an SD card for use	40
Left side panel.....	23	Using the built-in speaker	40
Right side panel.....	23	Connecting monitors and headphones	41
Bottom Panel.....	24	Using the built-in microphone	41
Home Screen	25	Setting the mics to record a wide stereo sound (A-B position).....	41
Recording Screen.....	27	Setting the mics to record a clear stereo sound (X-Y position).....	42
Playback Control screen	29		

Swapping the left-right channels of the built-in microphone pair	42
Microphone position detection.....	43
Attaching the tilt foot	44
4 – Recording	45
Selecting file format, sampling frequency, and maximum file size	45
Preparing the recording inputs	46
Recording with the built-in mics	46
Recording with external mics (EXT MIC IN)	46
Recording an external device (LINE IN)	47
Setting the external input type.....	48
Using phantom power	48
Adjusting the input level	49
Manually adjusting the input level.....	49
Using the Level Control Function.....	50
Overview of recording modes	51
Recording (MONO/STEREO recording)	52
Make recording settings.....	52
Set where to save the file	53
Starting the recording	53
File names when recording in MONO/STEREO	54
Simultaneously recording two files at different input levels (DUAL REC).....	54
Enabling dual recording	54
Starting dual recording	56
Dual recording file names	56
Recording 4 channels.....	57
Making 4-channel recording settings.....	57
Starting 4-channel recording	58
File names when recording in 4-channel	58
Recording playback and input sounds together (overdubbing)	58
Setting the overdubbing mode.....	59
Select the file you want to overdub	60
Start the overdubbing.....	60
File names when recording in overdubbing.....	61
Recording automatically (AUTO REC).....	62
Creating and changeover to a new file during continued recording (Track increment)	63
Manual track increment during recording	64
Automatic track increment by file size	64
Mark function.....	65
Adding marks manually to a recording.....	65
Adding marks automatically to a recording.....	65
Moving to a mark position.....	65
Setting the low cut filter.....	66
Recording the moment before pushing RECORD (PRE REC).....	66
Self-timer function	67
Solo function	67
Recording duration	68

Table of Contents

5 – Working with Files and Folders

(BROWSE screen)	69
Screen navigation	69
Icons on the BROWSE screen	70
File operations	70
Folder operations	72
Creating a new folder	73

6 – Playback

74	
Adjusting playback volume	74
Setting the playback area (AREA)	74
Selecting a folder for the playback area (1)	75
Selecting a folder for the playback area (2)	76
Playlist	77
Adding files to the playlist	77
Editing the playlist	77
Selecting files for playback (skip)	79
Playback	79
Pausing	80
Stopping	80
Rewinding and fast-forwarding (search)	80
Repeat playback (REPEAT)	80
Special Playback Control Functions	81
Playback Control Screen	81
Repeated Playback of Selection (Loop Playback)	82
Changing the playback speed (VSA)	83
Using the playback equalizer (PLAY EQ)	83

Moving back a few seconds for replay (jump-back playback)	84
Playback of files recorded using dual recording	84
OVERDUB INPUT MUTE function (during playback)	85
Solo function	85

7 – Quick Operations

86	
Features of the QUICK button	86
Quick menu screen	87
Closing the Quick menu screen	88
Deleting the selected file (Quick Delete)	88
Dividing the selected file (DIVIDE)	89
Increasing the perceived overall sound pressure to enhance listenability (Level Alignment)	90
Mixdown	91

8 – Using the Effects

92	
Setting the effect	92
Effects Preset List	93

9 – Mixer

94	
Making mixer settings	94
Using the MS decoder	95
Decoding the input sound as you record	95
Decoding the playback sound	95
MS decoder settings	95

10 – Tuning a Musical Instrument (Tuner)

97	
Using the tuner	97

Setting the tuner	97	Footswitch (TASCAM RC-3F)	106
Tuning a musical instrument	97	Setting footswitch operation	106
11 – Connecting with a computer	98	Using the footswitch	107
Transferring files to a computer	99	Mode functions	107
Transferring files from a computer	99	Remote control (TASCAM RC-10)	107
Disconnecting from a computer	99	Setting the wired remote control	107
12 – Settings and Information	100	Using the wired remote control	108
Viewing File Information	100	Overview of mode functions	108
File information page	100	14 – Messages	109
Card information page	101	15 – Troubleshooting	112
System information page	101	16 – Specifications	114
System Settings and Formatting	101	Ratings	114
Turning the unit power OFF automatically	102	Input/output ratings	114
Setting the backlight	102	Analog audio input/output ratings	114
Adjusting the display contrast	102	Control input/output ratings	115
Setting the type of AA batteries	102	Audio performance	115
Setting the phantom power voltage	102	Computer compatibility	115
Restoring the factory settings	103	Other specifications	116
Using QUICK FORMAT	103	Dimensional drawings	117
Using FULL FORMAT	103		
Setting the format of file names	104		
File name format	104		
Setting the WORD item	105		
Resetting the number (COUNT)	105		
13 – Using the REMOTE jack	106		

Quick Start Guide

Try recording and playback with TASCAM DR-40.

The unit contains a factory-installed SD card, and will by default produce 44.1 kHz, 16-bit WAV files.

Higher-quality or longer files can be produced using other recording settings. See “Selecting file format, sampling frequency, and maximum file size” for details on page 45.

- 1 Install batteries in the battery compartment on the back of the unit. Fit them to the + and – marks shown in the compartment.**

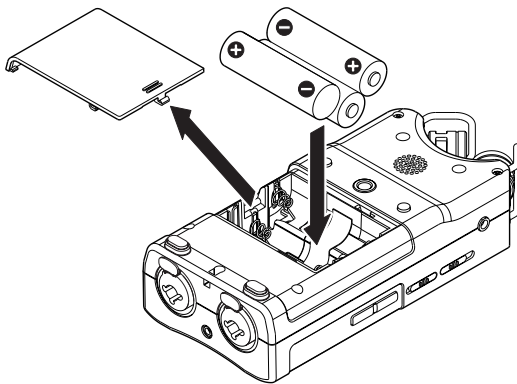

- 2 Turn on, and various setting information will be displayed.**

Press the \odot / \blacksquare (HOME) [\blacksquare] button until the unit is turned on, and then release it.

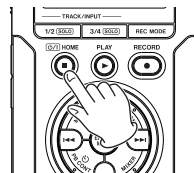

CAUTION

The first time you use the unit, a built-in clock setting screen will appear.

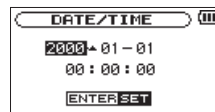

Press the \blacktriangleleft or \blacktriangleright button to move the cursor (highlighted portion), and adjust the date and time using the + or – button. Then press the ENTER/MARK button to set.

- 3 Press the **RECORD** [●] button to switch to recording standby. The indicator will flash.

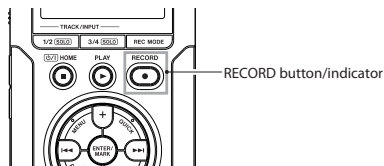

NOTE

If the **L-R** or **R-L** icon appears in the upper right of the Home Screen, the adjustment for the angle and the left-right channels of the microphone do not suit the recording setting. Change the settings. (See “Using the built-in microphone” on page 41.)

- 4 Use the **INPUT LEVEL +** or **-** button on the left side panel to adjust the input level. See “Adjusting the input level” on page 49 for details.
- 5 Press the **RECORD** [●] button to start recording. The indicator will light during recording.
- 6 Press the **⏏** / **|** (HOME) [■] button to finish recording.

NOTE

To pause recording, press the **RECORD** [●] button. Press the **RECORD** [●] button again to restart recording in the same file.

- 7 Press the **PLAY** [▶] button for playback. If you use a headphone or amplifier/speaker set, connect it to the **LINE OUT** socket on the left side panel. For playback over the built-in speaker, enable it on the speaker settings screen (See “Using the built-in speaker” on page 40.)

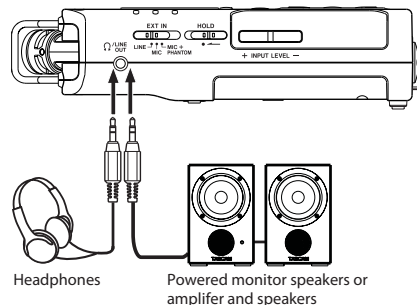

- 8 Use the **+ or -** button to control the playback volume.
- 9 Press the **⏏** / **|** (HOME) [■] button to stop playback.

NOTE

If you have made several recordings, use the **◀◀** or **▶▶** button to select the file to play when playing back or stopped and the Home Screen is displayed.

1 – Introduction

Thank you very much for purchasing the TASCAM DR-40 Linear PCM Recorder. Please read this Owner's Manual carefully in order to maximize your use of all the unit's features. We hope that you will enjoy using this recorder for many years to come. After you have finished reading this manual, please keep it in a safe place for future reference.

You can also download the Owner's Manual from the TASCAM web site (<http://tascam.com/>).

Features

- Compact audio recorder that uses SD/SDHC cards as recording media
- High-performance directional stereo mics can be adjusted, enabling both A-B and X-Y recording
- Can record with different types of stereo sound depending on the angle of the microphones
 - Close: Clear Stereo Sound with less phase difference
 - Open: Wide Stereo Sound
- Mid-side decoding function can be used with MS mics
- Recording of up to four channels simultaneously possible
- 44.1/48/96 kHz, 16/24-bit, linear PCM (WAV format) recording possible
- Compatible with BWF format
- 32–320 kbps MP3 format recording possible (compatible with ID3 tag v2.4)
- Dual recording allows two files to be recorded simultaneously at different levels
- Overdubbing in mix mode allows the playback signal and the input signal to be mixed and recorded as a new file
- Overdubbing in separate mode allows the playback signal and the input signal to be mixed and recorded as a new file, while saving the original file
- Built-in 0.3 W monaural monitor speaker
- Built-in effect (reverb) can be used during recording and playback
- Auto-record function starts recording automatically when a set sound input level is detected
- Can start recording a new file automatically when a maximum file size set in advance is reached without interrupting recording
- A QUICK button is available for easy access to various functions
- Track incrementing function allows a recording to be split by creating a new file when desired
- Pre-recording (PRE REC) function allows the unit to record the 2 seconds of sound before recording is activated
- Peak reduction function is available to reduce the level automatically in case of excessively large input.

- Automatic level control is available to increase or decrease the recording volume when the input sound is too low or too high, respectively.
- Limiter function automatically reduces the level suitably in particular portions where the input level is too high
- Low cut filter conveniently reduces low-frequency noise
- VSA function can change the playback speed in the range from 0.5 to 1.5 times (in 0.1 increments) the normal speed without changing pitch
- Repeat playback and IN-OUT loop playback functions
- PB CONTROL button is available to show settings screens for playback speed control and IN-OUT loop
- Tuner function to tune musical instruments
- Self-timer function to start recording after a set period of time.
- Jump back and play function allows the last several seconds of the currently played file to be replayed again by simply pressing a button
- Delay compensation function that eliminates time lags caused by differences in the distances of two sets of inputs from the sound source
- Playlist function
- DIVIDE function allows files to be split where desired (only for WAV files)
- MARK function convenient for moving to specific locations
- Equalizers function for playback, and level alignment function to enhance the perceived overall sound pressure
- File name format can be set to use a user-defined word or the date
- Resume function to memorize the playback position before the unit is turned off.
- 3.5 mm (1/8") line/headphones output jack
- 128 x 64 pixel LCD with backlight
- Mini-B type USB 2.0 port
- Operates on 3 AA batteries, an AC adaptor (sold separately: TASCAM PS- P515U), or USB bus power
- Tripod attachment screw-hole built into unit
- USB cable included
- Mic inputs can provide +24V/+48V phantom power
- Two balanced mic/line inputs (XLR/TRS combo jacks)

1 – Introduction

Items included with the product

The DR-40 package contains the following items.

Take care when opening the package not to damage the items. Keep the package materials for transportation in the future.

Please contact the retailer where you purchased this unit if any of these items are missing or have been damaged during transportation.

- Main unit 1
- SD memory card (in the unit)..... 1
- AA alkaline batteries 3
- USB cable (80 cm)..... 1
- Tilt foot 1
- Warranty card 1
- Owner’s Manual (this document) 1

Conventions used in this manual

The following conventions are used in this manual.

- When we refer to a button or connector or control on the DR-40, the typeface looks like this: **MENU**.
- When we show messages, for example, that appears on the unit’s display, the typeface looks like this: REPEAT.
- When we show messages, for example, that appear on the computer’s screen, we show them like this: DR-40.
- “SD memory card” is sometimes abbreviated as “SD card.”
- Additional information is introduced in the styles below when needed:

TIP

We give hints and tips on using the DR-40 when you see this icon.

NOTE

A note provides additional explanations for special situations.

CAUTION

A caution shows that you may lose data (recordings) if you do not follow the instructions.

Intellectual property rights

- TASCAM is a trademark of TEAC Corporation, registered in the U.S. and other countries.
- SDHC Logo is a trademark of SD-3C, LLC.



- Supply of this product does not convey a license nor imply any right to distribute MPEG Layer-3 compliant content created with this product in revenue-generating broadcast systems (terrestrial, satellite, cable and/or other distribution channels), streaming applications (via Internet, intranets and/or other networks), other content distribution systems (pay-audio or audio-on-demand applications and the like) or on physical media (compact discs, digital versatile discs, semiconductor chips, hard drives, memory cards and the like). An independent license for such use is required. For details, please visit <http://mp3licensing.com>.
- MPEG Layer-3 audio coding technology licensed from Fraunhofer IIS and Thomson.
- Microsoft, Windows, Windows XP, Windows Vista, and Windows 7 are either registered trademarks or trademarks

of Microsoft Corporation in the United States and/or other countries.

- Apple, Macintosh, iMac, Mac OS and Mac OS X are trademarks of Apple Inc.
- Other company names, product names and logos in this document are the trademarks or registered trademarks of their respective owners.

Any data, including, but not limited to information, described herein are intended only as illustrations of such data and/or information and not as the specifications for such data and/or information. TEAC Corporation disclaims any warranty that any use of such data and/or information shall be free from infringement of any third party's intellectual property rights or other proprietary rights, and further, assumes no liability of whatsoever nature in the event of any such infringement, or arising from or connected with or related to the use of such data and/or information.

1 – Introduction

This product is designed to help you record and reproduce sound works to which you own the copyright, or where you have obtained permission from the copyright holder or the rightful licensor. Unless you own the copyright, or have obtained the appropriate permission from the copyright holder or the rightful licensor, your unauthorized recording, reproduction or distribution thereof may result in severe criminal penalties under copyright laws and international copyright treaties. If you are uncertain about your rights, contact your legal advisor. Under no circumstances will TEAC Corporation be responsible for the consequences of any illegal copying performed using the recorder.

About SD cards

This unit uses SD cards for recording and playback.

You can use 64 MB–2 GB SD cards and 4 GB–32 GB SDHC cards with this unit.

A list of SD cards that have been tested with this unit can be found on the TASCAM web site (<http://tascam.com/>).

Use of cards that have not been verified for use with this unit could result in the unit not functioning properly.

Precautions for use

SD cards are delicate media. In order to avoid damaging a card or the card slot, please take the following precautions when handling them.

- Do not leave in extremely hot or cold places.
- Do not leave them in extremely humid places.
- Do not let them get wet.
- Do not put things on top of them or twist them.
- Do not hit them.

Precautions for placement and use

- The operating temperature should be between 0°C and 40°C (32°F and 104°F).
- Do not install in the following types of places. Doing so could degrade the sound quality and/or cause malfunctions.
 - Places with significant vibrations or that are otherwise unstable
 - Near windows or other places exposed to direct sunlight
 - Near heaters or other extremely hot places
 - Extremely cold places
 - Places with bad ventilation or high humidity
 - Very dusty locations
 - Places that could be directly exposed to rain or other water
- Avoid installing this unit on top of any heat-generating electrical device such as a power amplifier.

Beware of condensation

If the unit is moved from a cold to a warm place, or used after a sudden temperature change, there is a danger of condensation; vapor in the air could condense on the internal mechanism, making correct operation impossible. To prevent this, or if this occurs, let the unit sit for one or two hours at the new room temperature before using.

Cleaning the unit

Use a dry soft cloth to wipe the unit clean. Do not clean the unit with a chemically treated cloth or substances such as benzene, thinner and alcohol because they might cause damage to the surface of the unit.

User registration

See the end of this manual for details about user registration.

2 – Names and Functions of Parts

Top panel

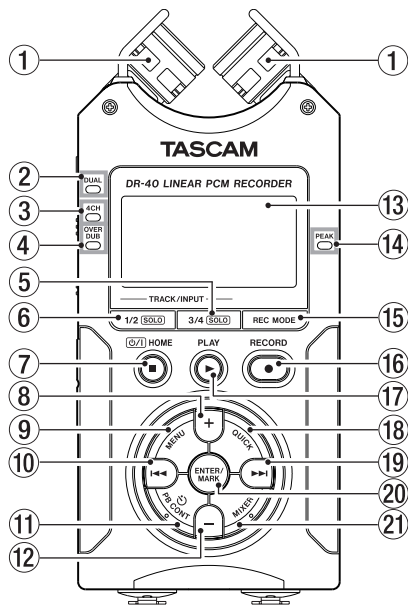

- 1 Built-in stereo microphone**
Cardioid stereo electret condenser microphone. You can set the microphone angles to open (A-B), or close (X-Y).
- 2 DUAL indicator**
This lights orange when recording in dual recording mode.
- 3 4CH indicator**
This lights orange when recording in 4-channel recording mode.
- 4 OVER DUB indicator**
This lights orange when recording in overdubbing mode.
- 5 3/4 [SOLO] button**
When in 4-channel recording mode, press this to open a display pull-up that shows meters with the input level settings for 3/4.
Press when the 1/2 input level meter pull-up is displayed to switch to the 3/4 input level meter pull-up.
Press and hold when recording or playing back in DUAL or 4CH mode to use the solo function, which switches the monitored sound to sources other than channels 1 and 2.
Press and hold to solo channels 3 and 4.
- 6 1/2 [SOLO] button**
Press this to open a display pull-up that shows meters with the input level settings for 1/2.

2 – Names and Functions of Parts

Press when the 3/4 input level meter pull-up is displayed to switch to the 1/2 input level meter pull-up.

Press and hold when recording or playing back in DUAL or 4CH mode to use the solo function, which switches the monitored sound from other sources to channels 1 and 2.

Press and hold to solo channels 1 and 2.

⑦ / **I(HOME) [■] button**

Press this button during playback to cause the playback to pause at the current position. Press this button during pause time to return to the beginning of the playback file. Press this button during recording or recording standby to cause the recording to stop.

When any other screen is open, press this button to return to the Home Screen. Use this button to answer “NO” to a confirmation message.

Press and hold this button to turn the unit’s power ON or OFF.

⑧ **+ button**

When the Home Screen is displayed, press this button to increase the output level from the built-in speaker or /LINE OUT jack. During adjustment, a volume indicator will be displayed in a pull-up window.

When the Playback Control screen is displayed, press this button to increase the playback speed.

When a setting screen is open, use the button to change the setting of the selected item.

⑨ **MENU button**

When the Home Screen is displayed, press this button to open the MENU Screen.

Press this button to return to the MENU Screen from the various setting screens.

When the MENU Screen is displayed, press this button to return to the Home Screen.

When the IN and OUT points are set in the file and the Playback Control screen is displayed, press this button to turn on or off loop playback.

⑩ button

Press this button to return to the beginning of a playback file that is playing or stopped in the middle. When the IN and OUT points are set between the current position and the beginning of the playback file, pressing this button skips to those points.

If you press this button when a file is stopped at its beginning, the unit will skip to the beginning of the previous file.

Press and hold this button to search backwards.

Press this button while pressing and holding the **ENTER/MARK** button to return to the previous mark.

2 – Names and Functions of Parts

On the setting screens, use this button to move the cursor left. On the **BROWSE** Screen, press this button to move up a level.

⑪ **PB CONT button**

This button activates the Playback Control screen. When the Playback Control screen is displayed, press this button to return to the Home Screen.

Press this button during recording standby to turn off the self-timer function or change the time period.

⑫ **– button**

When the Home Screen is displayed, press this button to decrease the output level from the built-in speaker or **Ω/LINE OUT** jack. During adjustment, a volume indicator will be displayed in a pull-up window.

When the Playback Control screen is open, press this button to decrease the playback speed.

When a setting screen is open, use the button to change the setting of the selected item.

⑬ **Display**

Shows a variety of information.

⑭ **PEAK indicator**

Lights when the input volume is too high.

⑮ **REC MODE button**

Press this button to open the **REC MODE** screen.

When the **REC MODE** screen is open, press this button to return to the Home Screen.

⑯ **RECORD [●] button/indicator**

Press this button when stopped to start recording standby. The recording indicator will blink when in standby.

Press this button when in recording standby to start recording. The recording indicator will light when recording.

Press this button when recording to pause recording.

⑰ **QUICK button**

When playing back, stopped, paused or in recording standby in the Home Screen or when the Playback Control screen is displayed, press this button to display the Quick Menu screen. The function to be shown depends on the state of the unit when the button is pressed.

- Stopped: delete, division, level alignment, or mixdown for the current playback file
- Playback/Playback Control screen: level alignment
- Recording standby: level control, swap left and right built-in mics
- **MIXER** screen: **MS DECODER** setting

When the **BROWSE** screen or **PLAYLIST** screen is displayed, press this button to show or cancel the popup menu for file/folder operations.

18 ►► button

Press this button during playback or when playback is stopped to skip to the beginning of the next file. When the IN and OUT points are set between the current position and the end of the file, pressing this button skips to those points.

Press and hold this button to search forward.

On the setting screens, use this button to move the cursor right.

Press this button while pressing and holding the **ENTER/MARK** button to move to the next mark.

On the **BROWSE** Screen, press this button to move down a level. If a file is selected, the file is loaded and the unit returns to the Home Screen and stops.

19 **PLAY [▶] button**

When the Home Screen is displayed and playback is stopped, press this button to start playback.

During playback, press this button to start jump-back playback.

When a file or folder is selected in the **BROWSE** screen, press this button to return to the Home Screen and play the file or the first file in the folder from the beginning.

20 **ENTER/MARK button**

Use this to confirm the selection of a setting item or to answer “YES” to a confirmation message.

When recording, use it to add markers manually.

Press the ◀◀ or ▶▶ button while pressing and holding this button to move to the previous or next mark, respectively.

When the Playback Control screen is open, use this button to set the IN (start) and OUT (end) points of the interval that you want to set for loop playback. When the IN and OUT points are already set, press this button to cancel loop playback and clear the IN and OUT points.

21 **MIXER button**

Press this button to open the **MIXER** screen.

When the **MIXER** screen is open, press this button to return to the Home Screen.

2 – Names and Functions of Parts

Front panel

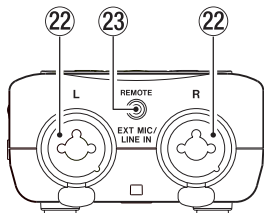

22 EXT MIC/LINE IN L/R jacks (XLR/TRS)

These are balanced analog XLR/TRS combo jacks for microphone and line level inputs.

XLR (1: GND, 2: HOT, 3: COLD)

TRS (Tip: HOT, Ring: COLD, Sleeve: GND)

CAUTION

- Confirm that phantom power is OFF before connecting a line level device to a **EXT MIC/LINE IN** jack. If you connect a line level device while phantom power is being supplied, that device and this unit could be damaged.
- When using a condenser microphone, before connecting to and disconnecting from a **EXT MIC/LINE IN** jack, confirm that the phantom power for that jack is OFF. If you connect or disconnect a mic while phantom power is being supplied, that mic and this unit could be damaged.

- Do not connect an unbalanced dynamic mic to an XLR connector when phantom power is being supplied. Doing so could damage that mic and this unit.

23 REMOTE jack (2.5 mm dia. TRS jack)

Connect a TASCAM RC-3F footswitch or TASCAM RC-10 wired remote control (both sold separately) here to enable remote starting and stopping of playback and other functions.

Left side panel

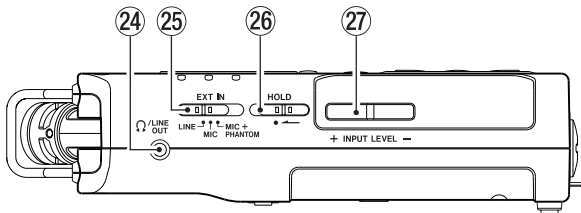

- ②④ **Ω/LINE OUT jack**
Use this to connect with headphones or the line input jack of an amp or other equipment.
- ②⑤ **EXT IN switch**
Use this to set the input type of the **EXT MIC/LINE IN** jacks and whether phantom power is on or off.
- ②⑥ **HOLD switch**
Shift to the left end (in the direction of the arrow) to engage the hold function.
All buttons are inoperative when hold is ON.
- ②⑦ **INPUT LEVEL (+/-) buttons**
Use these to adjust the input level.
During adjustment, the input level setting status will be displayed in a pop-up window.

Right side panel

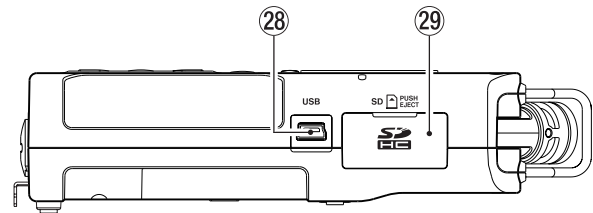

- ②⑧ **USB port**
Use the included USB cable to connect with a computer USB port.
Power can be supplied through the USB cable provided with the unit or an AC adaptor (sold separately: TASCAM PS-P515U).
- NOTE**
Always connect the recorder directly to a computer. Do not use a USB hub.
- ②⑨ **SD card slot**
Insert an SD card into this slot.

2 – Names and Functions of Parts

Bottom Panel

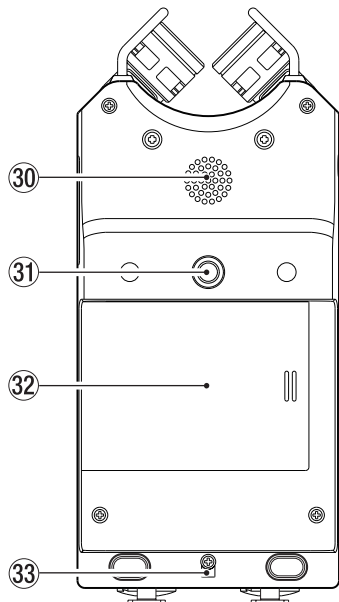

- 30 Mono speaker**
Use this built-in speaker to listen to recordings.

The speaker will not produce sound in the following situations.

- When in recording standby
- When headphones are connected
- When recording
- When the speaker output setting is off
- When in overdubbing mode

- 31 Mounting thread for tripod or tilt foot (1/4-inch)**
Use this to attach a tripod or the included tilt foot to the recorder.

CAUTION

- Tighten the unit securely to the tripod or microphone stand to prevent it from falling off.
 - Place the tripod or microphone stand on a level surface when using it with this unit.
- 32 Battery compartment cover**
When not using the included tilt foot, it can be stored by inserting it between the two protrusions on the inside of the battery compartment cover.
- 33 Hole for strap**

2 – Names and Functions of Parts

34 Battery compartment

Install batteries (3 AA) in this compartment to power the unit. (See "Using AA batteries" on page 34.)

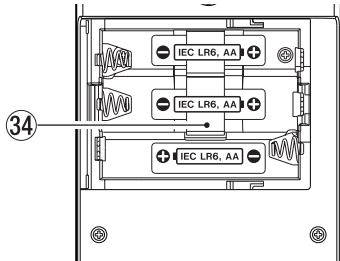

Home Screen

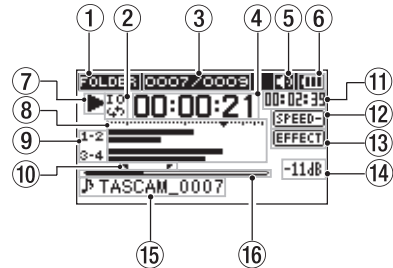

① Playback area

- ALL All files in the MUSIC folder
- FOLDER All files in the selected folder
- PLAYLIST All files added to the playlist

② Loop/repeat playback status

- : Single playback
- : Single file repeat playback
- : All file repeat playback
- : Loop playback

③ Current playback file number/total number of files

This shows the current file number and total number of files in the current playback area.

2 – Names and Functions of Parts

④ Elapsed time







This shows the elapsed time (hours: minutes: seconds) of the current file.

⑤ Speaker output status

 Icon shown: Speaker output ON

 Icon not shown: Speaker output OFF

⑥ Power supply status

When a battery is being used, a battery icon shows the amount of power remaining in bars (, , , ). The battery is almost dead and the power will soon turn off if the icon has no bars . When using the PS-P515U AC adaptor (sold separately) or USB bus power,  appears.

NOTE

Sometimes a **Battery Low** warning appears when recording or conducting other demanding operations even when battery power remains.

⑦ Recorder operation status

■ Stopped

|| Paused

▶ Playing back

▶▶ Fast-forwarding

◀◀ Fast-rewinding

▶▶| Skipping forward

|◀◀ Skipping backward

⑧ Level meter

The level of the input or playback sounds is shown.

During OVER DUB (MIX), this shows the mixed level of the input and playback signals.

⑨ Track status display

The display changes according to the recording mode.

L : Playing a file recorded in MONO or STEREO mode
R :

INT or **EXT** : Playing a file recorded in dual recording mode
-S | or **-S** | :

1-2 : Playing a file recorded in 4-channel recording mode
3-4 :

1-2 | **1-2** : In OVERDUB SEPARATE mode
INT | or **EXT** | :

1-4 | **1-4** : In OVERDUB MIX mode
INT | or **EXT** | :

NOTE

When a track is soloed, its name appears highlighted .

⑩ Loop playback IN (starting) and OUT (ending) points

The set starting and ending points of the loop are shown.

The  icon appears at the playback position when the starting point is set.

The  icon appears at the playback position when the ending point is set.

2 – Names and Functions of Parts

⑪ Remaining time

This shows the remaining time (hours: minutes: seconds) of the current file.

⑫ Playback speed setting status

Indication	Playback speed
	x1.0
	x1.1 - x1.5
	x0.5 - x0.9
	Playback speed not controllable

⑬ Effect status

Shows whether the effect function is ON or OFF.

: Effect off

: Effect on

⑭ Peak value in decibels (dB)

The maximum level that occurs in a fixed period of time is displayed digitally.

⑮ File name

This shows the name of the file playing back or its tag information.

ID3 tag information is shown when available for an MP3 file being played.

Two project names are shown when there are two files that have been recorded in 4-channel recording mode, dual recording mode or overdub separate mode.

NOTE

ID3 tag information includes the titles and artists names that can be saved in MP3 files.

⑯ Playback position display

The current playback position is shown by a bar. As playback progresses, the bar extends to the right.

Recording Screen

This screen appears when recording or in recording standby.

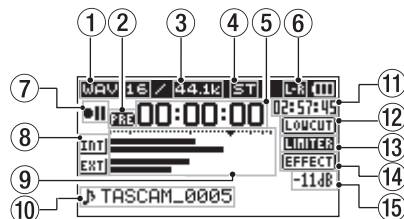





⑰ Recording format



This shows the file recording format.







WAV 16/WAV 24/BWF 16/BWF 24/MP3 320k/MP3 256k/
MP3 192k/MP3 128k/MP3 96k/MP3 64k/MP3 32k

2 – Names and Functions of Parts

- ② **Prerecording or Auto recording function status**
 appears when the prerecording function is ON, and in recording standby.
 appears when the auto recording function is ON, and recording.
- ③ **Recording sampling frequency**
This shows the file recording sampling frequency.
44.1k/48k/96k
- ④ **Number of recording channels**
This shows the number of recording channels in the file.
ST/MONO
- ⑤ **Elapsed recording time**
The elapsed recording time of the file appears as hours: minutes: seconds.
- ⑥ **Left-right setting of built-in stereo mics**
When not correct for the mic angle setting, the current left-right setting of the built-in stereo mics is shown.

Indications	Mic angles	Mic settings
	Closed (X-Y)	L-R
	Open (A-B)	R-L

- ⑦ **Recorder operation status**
-  Recording standby or Recording paused
 -  Recording

- ⑧ **Input source**
This icon shows the input source.
- : Input source set to built-in mics
 - : Input source set to **EXT MIC/LINE IN** jacks
 - : Input source set to DUAL for dual recording
Setting range is between -6 and -12
 - : When in OVERDUB SEPARATE mode, this shows that channels 1/2 are a playback file.
 - : When in OVERDUB MIX mode, this shows that the input source is set to a mix of the playback file and built-in mic signals
 - : When in OVERDUB MIX mode, this shows that the input source is set to a mix of the playback file and **EXT MIC/LINE IN** jack signals

NOTE

When a track is soloed, its name appears highlighted .

- ⑨ **Recording level meters**
The input signal level is shown.
During overdub recording, the level of the combined input and playback sounds is shown.
A ▼ mark is given at the -12 dB position on the scale as a guide mark for input level adjustment.

2 – Names and Functions of Parts

⑩ File name

This shows the file name that is automatically assigned to a recording file.

The project name is shown when multiple files have been recorded in 4-channel recording mode, dual recording mode or OVERDUB SEPARATE mode.

⑪ Remaining recording time

The remaining recording time until the selected max file size is reached appears in hours: minutes: seconds.

If the remaining recording time on the card is less than the remaining time until the selected max file size is reached, the remaining recording time on the card is displayed.

⑫ Low cut filter status

This shows whether the low cut filter is ON/OFF. The icon appears highlighted when set to 40Hz, 80Hz or 120Hz.

LOWCUT : Low cut filter off

LOWCUT : Low cut filter on

⑬ Level control function status

OFF : Level control off

PEAK : Peak reduction on

AUTO : Automatic level control on

LIMITER : Limiter on

⑭ Effect status

Shows whether the effect function is ON or OFF.

EFFECT : Effect off

EFFECT : Effect on

⑮ Peak value in decibels (dB)

Peak input level values are shown digitally.

Playback Control screen

The Playback Control screen is displayed if the **PB CONT** button is pressed during playback or when playback is stopped.



① Loop playback status

The  icon is displayed when loop playback is enabled.

② Playback speed

Playback speed as compared with the normal speed is shown.

2 – Names and Functions of Parts

VSA shown on the left to indicate that the VSA (variable speed audition: enables the tempo to be changed without changing the pitch) function is enabled.

③ Available buttons

The buttons available in the Playback Control screen are as follows.

ENTER : Creates or deletes an IN or OUT point.

MENU : Switch over between ON and OFF status of the loop playback function.

NOTE

- Unlike the other screens, the **QUICK** button in this screen works to display the quick menu containing only the LEVEL ALIGN function, and no other functions will be available.
- Recording is not possible on this screen.
- On this screen, the ◀◀ and ▶▶ buttons can be used to skip to loop IN (starting) and OUT (ending) points and the beginnings and ends of files, but not to the previous or next tracks.

④ Loop playback IN (starting) and OUT (ending) points

The set starting and ending points of the loop are shown.

The  icon appears at the playback position on the bar when the starting point is set.

The  icon appears at the playback position on the bar when the ending point is set.

⑤ Playback position display

The current playback position is shown by a bar. As playback progresses, the bar extends to the right.

Menu item list

This list provides an overview of the various menu items.

Menu item	Function	Pages
REC SETTING	Recording mode settings	45
PLAY SETTING	Play area select, repeat setting, playback equalizer, jump-back settings	74, 80, 83
BROWSE	SD card file and folder operations	69
SPEAKER	ON/OFF status of built-in speaker	40
OTHERS	OTHERS submenu display	31

2 – Names and Functions of Parts

The OTHERS submenu appears when OTHERS is selected in the MENU screen. The menu items contained are as follows.

Submenu item	Function	Pages
INFORMATION	Information about the file, SD card, and system	100
TUNER	Tuner settings	97
EFFECT	Effects settings	92
FILE NAME	File name settings	104
DATE/TIME	Date and time settings	37
REMOTE	Settings for the TASCAM RC-3F footswitch and TASCAM RC-10 wired remote control (both sold separately)	106
SYSTEM	Various system settings	101

CAUTION

- When recording/in recording standby, the following screens and items are shown.
 - LOW CUT and AUTO REC setting MODE and LEVEL on the REC SETTING screen (AUTO REC settings are shown, but cannot be changed)
 - EFFECT, PRESET, LEVEL and SOURCE on EFFECT screen
- The **MENU** button is disabled in the Playback Control screen, but works to change over between ON and OFF status of the loop playback function. (See “Repeated Playback of Selection (Loop Playback)” on page 82.)

Using menus

Use the MENU screen to make various settings.

Example: setting the playback area

- 1 Press the **MENU** button to open the MENU screen.



- 2 Use the **+ or –** button to select a menu item (highlighted), and use the **ENTER/MARK** or **▶▶** button to move to various settings screens.

Example: PLAY SETTING screen



- 3 Use the **+ or –** button to select a menu item (highlighted) to be set.

Example: AREA is selected.

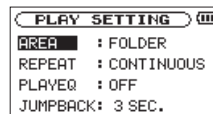

2 – Names and Functions of Parts

- 4 Use the **ENTER/MARK** or **▶▶|** button to move the cursor to highlight the value of the setting.

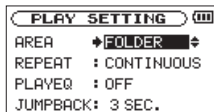

- 5 Use the **+** or **-** button to change the setting.
- 6 Press the **◀◀|** button to set a different item in the same menu.
This enables you to select a new item. Use the **+** or **-** button again to select an item to be set.
- 7 Repeat step 3 to 6 as necessary to set each item.
- 8 To open the **MENU** screen (or **OTHERS** submenu screen), press the **MENU** button.
To return to the Home Screen, press the **⏪/| (HOME) [■]** button.

Basic operation

Use the following buttons to operate the various screens.

MENU button:

Opens the **MENU** screen.

PB CONT button:

This opens the Playback Control screen.

⏪/| (HOME) [■] button:

When any other screen is open, press this to return to the Home Screen. Use this to answer “NO” to a confirmation message.

ENTER/MARK button:

Use this to confirm the selection of a setting item or to answer “YES” to a confirmation message.

▶▶| button:

Use this to move the cursor (the highlighted area) to the right on the screen, and to open folders on the **BROWSE** screen.

◀◀| button:

Use this to move the cursor (the highlighted area) to the left on the screen, and to close folders on the **BROWSE** screen.

2 – Names and Functions of Parts

+ button:

Use this to move the cursor (the highlighted area) upward on the screen, or increase values.

– button:

Use this to move the cursor (the highlighted area) downward on the screen, or decrease values.

QUICK button:

This opens the Quick menu.

- **Stopped:** current playback file deletion, division, level alignment and mixdown functions
- **Playing back/playback control screen:** level alignment function
- **Recording standby:** level control function, mic left-right swapping function

A popup menu is turned on or off in the **BROWSE** screen or **PLAYLIST** screen.

Press when the **MIXER** screen is open to set the MS decoder.

REC MODE button

Opens the **REC MODE** screen.

When the **REC MODE** screen is open, returns to the Home Screen.

MIXER button

Opens the **MIXER** screen.

When the **MIXER** screen is open, returns to the Home Screen.

1/2 [SOLO] button

Opens a meter display that shows the 1/2 input level setting status.

In **DUAL** or **4CH** mode, press and hold during recording or playback to solo channels 1/2.

3/4 [SOLO] button

Opens a meter display that shows the 3/4 input level setting status.

In **DUAL** or **4CH** mode, press and hold during recording or playback to solo channels 3/4.

3 – Preparation

Powering the unit

DR-40 can operate on three AA batteries, or through an optional AC adapter (TASCAM PS-P515U) or USB cable provided with the unit (USB bus power).

Alkaline or Ni-MH batteries can be used.

Using AA batteries

Open the battery compartment cover on the back of the unit. Fit three AA batteries to the + and – marks shown in the compartment, and close the battery compartment cover.

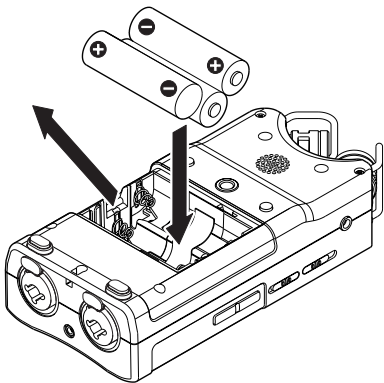

When using AA batteries, set the type of battery in order to accurately show the amount of power remaining and allow the unit to accurately determine whether power is available for proper operation. (See “Setting the type of AA batteries” on page 102.)

NOTE

- Manganese dry cell batteries (R6) cannot be used with this unit.
- This unit cannot recharge Ni-MH batteries. Use a commercially available recharger.
- The included alkaline batteries are for confirming operation of the unit and might not last very long.
- Before putting the bottom battery in, put the ribbon inside the compartment first. Failure to do so could make removing the batteries difficult.
- A great amount of power is required to provide phantom power to a condenser microphone. If you use a condenser microphone while running the unit on AA batteries (Ni-MH rechargeable or alkaline), the operation time will be greatly shortened because of their low capacities. If you need to operate the unit for a long time, use the AC adaptor (TASCAM PS-P515U) or the USB cable provided with the unit (USB bus power).

Using an AC adaptor (sold separately)

Connect the PS-P515U AC adaptor and the USB cable to the USB port of the unit as shown in the illustration.

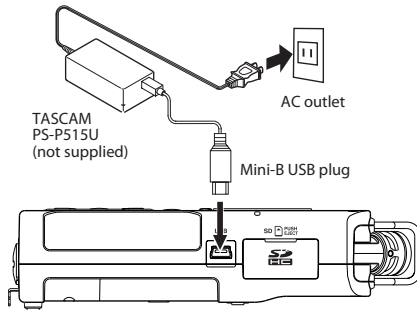

CAUTION

Never use any adaptor other than the designated PS-P515U AC adaptor. Use of a different adaptor could cause malfunction, fire or electric shock.

NOTE

- Noise may occur when recording with a microphone if the unit is too close to the AC adaptor. In such a case, keep sufficient distance between the AC adaptor and the unit.
- When both batteries are installed and the AC adaptor is connected, power will be supplied from the AC adaptor.

Using USB bus power

Connect the unit to a PC using the attached USB cable as shown in the illustration.

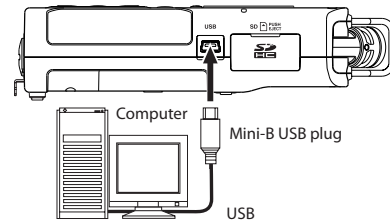

The USB SELECT screen appears to choose between USB bus power for power supply or connection with a PC through the USB cable when USB cable is connected after the unit is turned on or when the unit is turned on after connecting the USB cable. Use the + or – button to select **BUS POWER** and press the **ENTER/MARK** button to select power supply from the USB port. The Home Screen will appear.

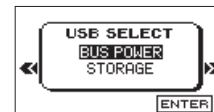

3 – Preparation

NOTE

- Power is supplied from the USB port if the USB cable is connected to the unit that contains batteries (USB bus power prioritized).
- The AC adaptor also connects using the USB cable, so set it to BUS POWER in the same way.

Start-up & shutdown

CAUTION

- The unit goes in standby mode if shut down when the unit is operating on AC power supplied through the AC adapter (TASCAM PS-P515U, sold separately), or bus power supplied from a USB port of a PC.
- Turn down the volume of the sound system connected to the unit before starting up or shutting down the unit.
- Do not use headphones when starting up or shutting down the unit. Otherwise, a large noise would cause damage to headphones or your ears.

Starting up the unit

To start up the unit from the stopped state, press and hold the **⏻ / | (HOME) [■]** button until TASCAM DR-40 (start-up

screen) is displayed on the display. The Home Screen appears when the unit starts up.



Start -Up Screen



Home Screen

CAUTION

When the unit is started up for the first time (or when the built-in clock is reset after being left unused without batteries), the **DATE/TIME** screen appears before the start-up screen to adjust the date and time.



Press the **◀◀** or **▶▶** button to move the cursor (highlighted area), and use the **+** or **-** button to change values.

Press the **ENTER/MARK** button to fix the settings.

The start-up screen is displayed, and then the Home Screen appears after the unit has started up.

Date/time adjustment may be skipped by pressing the **ENTER/MARK** button, and made later. (See “Setting the date and time” on page 37)

Shutting down

Press and hold the $\odot / |$ (HOME) [■] button until LINEAR PCM RECORDER appears on the display.

The power turns off after the unit completes its shutdown process.



CAUTION

Always use the $\odot / |$ (HOME) [■] button to shutdown the unit.

Do not remove the batteries or disconnect the power cable (AC adaptor TASCAM PS-P515U or USB cable) accidentally while the unit is operating. If you do so, the unit cannot shut down properly and all recordings, settings and other data will be lost. Lost data cannot be restored.

Resume function

The unit has resume function. When started up, the unit is located to the position (time) where it left off when shut down previously.

If the Playback button is pressed after start-up, the file the unit was playing when shut down previously starts to be played

from the position (time) where the unit left off when shut down.

NOTE

The required data are stored in the SD card. The resume function does not work if the card is exchanged or formatted.

Setting the date and time

Using its internal clock, this unit remembers the date and time when a file is recorded.

- 1 Press the MENU button to open the MENU screen.



- 2 Use the + or – button to select the OTHERS menu item (highlighted), and press the ENTER/MARK or ►► button.



The OTHERS screen is displayed.

3 – Preparation

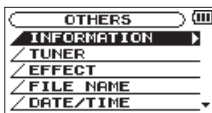

- 3 Use the + or – button to select the DATE/TIME menu item, and press the ENTER/MARK or ►► button.

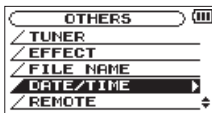

The DATE/TIME screen is displayed.



- 4 Press the ◀◀ or ►► button to move the cursor (highlighted area), and use the + or – button to change values.
- 5 Press the ENTER/MARK button to confirm the change and return to the OTHERS screen.

NOTE

You can set the unit to automatically add the date to file names. (See “Setting the format of file names” on page 104.)

CAUTION

The date and time setting can only be maintained for a few minutes if the unit is not powered from batteries or through the AC adaptor TASCAM PS-P515U or the USB cable. When using batteries, replace them before they completely lose power.

Inserting and removing SD cards

Inserting the SD card

NOTE

An SD card is already installed when the unit is shipped from the factory. If you want to use this card to record and play tracks, there is no need to reinstall it.

- 1 Open the SD slot cover on the right side panel.
- 2 Insert the SD Card into the slot as shown in the following illustration until it clicks into place.

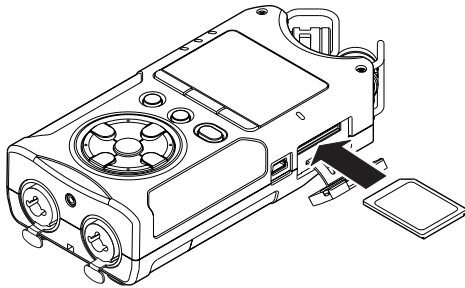

Removing the card

- 1 Open the SD slot cover on the right side panel.
- 2 Press the SD card in gently and then release it to allow it to come out.

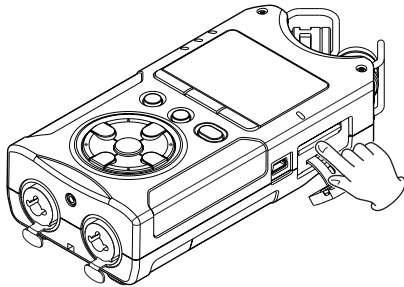

CAUTION

- Do not remove the SD card from the unit when it is connected to a computer by USB.
- SD cards that meet SD or SDHC standards can be used with this unit.
- A list of SD cards that have been confirmed to work with this unit can be found on our website (<http://tascam.com/>).

Card write protection

SD cards have protect switches that prevent writing new data to them.

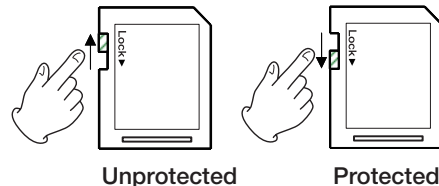

If you slide the protect switch to the "LOCK" position, file recording and editing is not possible. Move the switch to the unlocked position in order to record, erase and otherwise edit data on the card.

3 – Preparation

Preparing an SD card for use

In order to use an SD card in this unit, you must format it first.

CAUTION

- When formatting a card, the unit should be operating on AC power supplied through the PS-P515U adaptor (sold separately), USB bus power supplied from a computer, or batteries with sufficient remaining power.
- Formatting a card erases all the data on it.

- 1 **Confirm that an SD card is installed and turn the power ON.**
- 2 **The following message appears when a new card or a card formatted for use with another device is installed in the unit.**

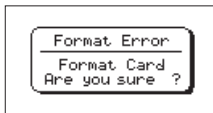

- 3 **Press the ENTER/MARK button to start formatting.**
- 4 **When formatting ends, the Home Screen opens.**
You can also reformat the card in this unit at any time. (See “System Settings and Formatting” on page 101.)

Using the built-in speaker

Enable **SPEAKER** on the **MENU** screen to allow the unit to play over the built-in speaker.

- 1 **Press the MENU button to open the MENU screen.**
- 2 **Use the + or – button to select the SPEAKER and press the ENTER/MARK or ►►I button.**

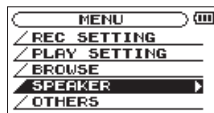

The **SPEAKER** screen is displayed.

- 3 **Use the + or – button to select ON.**





- 4 **When finished, press the ⏻ / |(HOME) [■] button to return to the Home Screen.**

NOTE

Even if **SPEAKER** is enabled, the unit will not play through the speaker when the unit is recording sound, in recording standby, or muted with headphones or external speaker system connected.

Connecting monitors and headphones

To listen with headphones, connect them to the /LINE OUT jack.

To listen with an external monitoring system (powered monitor speakers or an amplifier and speakers), connect it to the /LINE OUT jack.

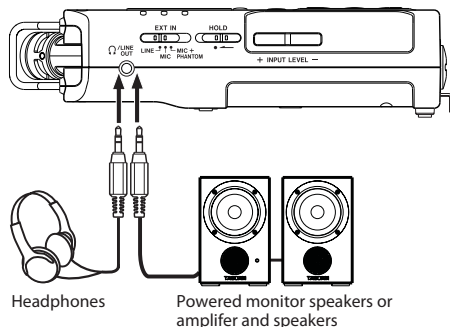

Using the built-in microphone

This unit's built-in microphones can be adjusted, allowing the angles of the microphones to be changed. You can choose clear stereo sound or wide stereo sound according to the recording source, situation, etc. by opening or closing the microphone pair.

Setting the mics to record a wide stereo sound (A-B position)

Spread the stereo microphone to the left and right. (A-B position)

Set this way, the two microphones are spread widely left and right, and recording is possible with a strong stereo field that is good for music, for example.

If you open or close the microphone pair while using the built-in stereo microphone and the left-right channels does not suit the angle of the microphone, a pop-up message appears to ask whether you want to swap the left-right channels of the microphone. (See "Microphone position detection" on page 43.)

3 – Preparation

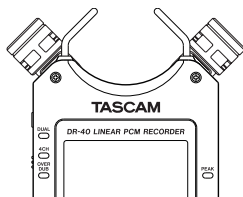

NOTE

Set the left-right channels of the built-in microphone to L-R. When you are using the built-in microphone and the setting is not L-R, **R-L** appears on the Home Screen. (See “Swapping the left-right channels of the built-in microphone pair” on page 42.)

Setting the mics to record a clear stereo sound (X-Y position)

Close the stereo microphone. (X-Y position)
Set this way, the microphone pair is close, and recording is possible with a clear stereo field with less phase difference. If you open or close the microphone pair while using the built-in stereo microphone and the left-right channels does not suit the angle of the microphone, a pop-up message appears to ask whether you want to swap the left-right channels of the microphone. (See “Microphone position detection” on page 43.)

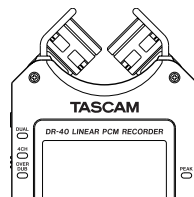

NOTE

Set the left-right channels of the built-in microphone to R-L. When you are using the built-in microphone and the setting is not R-L, **L-R** appears on the Home Screen. (See “Swapping the left-right channels of the built-in microphone pair” below.)

Swapping the left-right channels of the built-in microphone pair

Depending on the angles at which the microphones are set, the recording channels of the left and right microphones can be swapped.

When the microphone pair is open, the left microphone should be set to the left channel and the right microphone should be set to the right channel (When A-B position, L-R). When the microphone pair is closed, the left microphone should be set to the right channel and the right microphone should be set to the left channel (When X-Y position, R-L).

If you are using the built-in microphone and this setting is not used, the current microphone setting icon appears as a warning on the Home Screen.

1 Press the RECORD [●] button to bring the unit in recording standby.

The indicator will flash and the recording screen will appear.

2 Press the QUICK button.

The Quick menu screen will appear.



3 Use the + or – button to select (highlight) MIC LR SWAP, and press the ENTER/MARK button.

The MIC LR swap screen will appear.



4 Use the + button or – button to select (highlight) L-R or R-L depending on the microphone pair's status.

5 Press the ENTER/MARK button to fix the setting, and to return to the Home Screen.

Microphone position detection

The following pop-up message appears automatically whenever the left microphone is opened or closed and the left-right channels does not suit the angle of the microphone. If only the right microphone is opened or closed, it does not appear.



Press the **ENTER/MARK** button to change the setting.

Press the **⏪ / | (HOME) [■]** button to leave the setting as it is.

NOTE

- When you change the microphone angle setting and the pop-up message appears, you must press the **ENTER/MARK** button to change the L-R setting, press the **⏪ / | (HOME) [■]** button to keep this setting as is, or restore the previous microphone angle to close the pop-up message before you can begin recording.
- The pop-up message does not appear if you change the microphone position when recording. If necessary, use the **MIC LR SWAP** setting by pressing the **QUICK** button to switch the setting after change the setting to recording standby mode by pressing the **RECORD [●]** button.

3 – Preparation

Attaching the tilt foot

When recording with the built-in mics, placing the recorder with the battery compartment cover side down will cause the built-in mic orientation to be low. You can attach the included tilt foot to the tripod threads in order to keep the mic orientation from being too low.

Attach it as shown below.

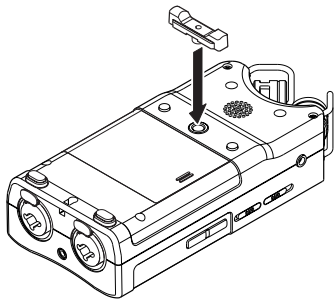

When not using the tilt foot, it can be stored by inserting it between the two protrusions on the inside of the battery compartment cover.

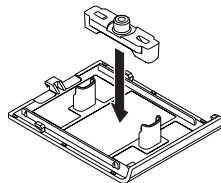

In addition to using the built-in microphone, you can record using an external microphone or record the output signal from a mixer or other audio source. You can select among MP3 (44.1/48 kHz, 32–320 kbps) and WAV/BWF (44.1/48/96 kHz, 16/24-bit) audio recording formats.

Marks added when recording to Broadcast Wave Format (BWF) can be used with software that supports this format, for example.

This recorder has five recording modes. Using the overdubbing function, you can mix input signals with an audio file that is played back and record either the combined signals or just the input signal as a new file. With dual recording you can simultaneously record the same input signals at two different levels. You can also use external mics with the built-in mics for 4-channel recording.

Selecting file format, sampling frequency, and maximum file size

Select the audio file type that you want to record before you start recording.

- 1 Press the **MENU** button to open the **MENU** Screen.
- 2 Use the **+ or –** button to select **REC SETTING**, and press the **ENTER/MARK** or **▶▶|** button.

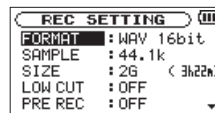

REC SETTING screen appears.

- 3 Use the **+ or –** button to select **FORMAT**, and press the **ENTER/MARK** or **▶▶|** button.

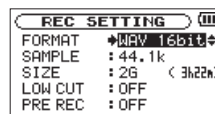

- 4 Set the file format with the **+ or –** button to one of the following options:

BWF: BWF 16bit, BWF 24bit

WAV: WAV 16bit (default), WAV 24bit

MP3: MP3 32k bps, MP3 64k bps, MP3 96k bps,
MP3 128k bps, MP3 192k bps, MP3 256k bps,
MP3 320k bps

NOTE

- BWF is a format created for broadcasting that has the same sound quality as the standard WAV format. It also uses the same “.wav” file extension as WAV files. In this manual, we distinguish these file types by using the terms BWF and WAV.

4 – Recording

- Higher values provide better recording quality.
- WAV/BWF files are higher quality than MP3 files, but they take up more space, so MP3 formats allow for longer recordings.

5 Press the $\blacktriangleleft\blacktriangleleft$ button to show settings.

6 Use the + or – button to select SAMPLE, and press the ENTER/MARK or $\blacktriangleright\blacktriangleright$ button.

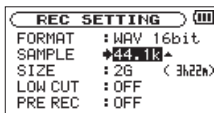

7 Set the sampling frequency with the + or – button to one of the following options.

44.1k (default), 48k, 96k

NOTE

96k cannot be selected if FORMAT is set to MP3.

8 Press the $\blacktriangleleft\blacktriangleleft$ button to show settings.

9 Use the + or – button to select SIZE, and press the ENTER/MARK or $\blacktriangleright\blacktriangleright$ button.

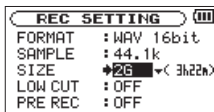

10 Set the maximum file size with the + or – button to one of the following options.

64M, 128M, 256M, 512M, 1G, 2G (default)

NOTE

- If the maximum set file size is exceeded during recording, the unit will automatically continue recording in a new file.
- Depending on the file format, the amount of recording time will differ for the same file size. The amount of recording time is shown on the right of the setting value (in parentheses).
- Recording automatically stops if recording time exceeds 24 hours.

11 Press the ⏪ / | (HOME) [■] button to return to the Home Screen.

Preparing the recording inputs

Recording with the built-in mics

Point the mics at the sound source and place the unit in a stable location where there is little vibration.

Recording with external mics (EXT MIC IN)

Connect external mics to the **EXT MIC/LINE IN** connectors.

Point the mics at the sound source and place the unit in a stable location where there is little vibration.

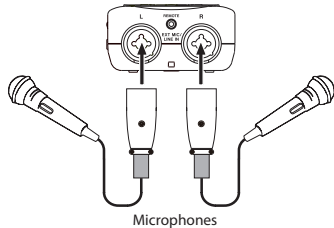

NOTE

The setting of left-right channels is disabled if external microphones are connected to the **EXT MIC/LINE IN** jack.

Recording an external device (LINE IN)

Use stereo plug cables to connect to the output of an external audio device.

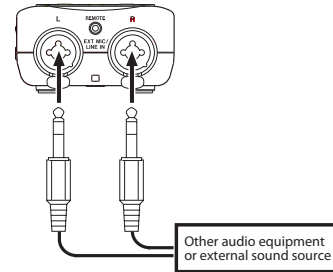

CAUTION

- Reduce the output level of the external audio device if the input sound is distorted even when reducing the input gain level on the unit.
- When an external audio device with a fixed output line level is connected, it would be impossible to control the gain level appropriately because of excessively large input signals. In such cases, use the headphone jack or other level-controllable output for connection to the unit.

4 – Recording

Setting the external input type

When using an external input source, set the **EXT IN** switch on the left side panel according to the type of equipment connected.

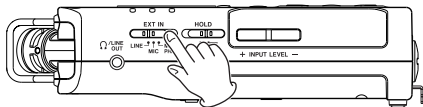

LINE:

Use this setting when connecting line output jacks of external devices to the analog inputs of this recorder.

MIC:

Use this setting when connecting mics to the recorder.

MIC+PHANTOM:

Use this setting when connecting condenser mics that require phantom power (+24V or +48V) to the recorder.

CAUTION

Depending on this setting, the input level setting range changes. For this reason, the input level might change greatly when this setting is changed. Before changing it, you should turn the power OFF or turn the output level all the way down.

Using phantom power

When the **EXT IN** switch on the left side panel is set to **MIC+PHANTOM**, phantom power (+24V or +48V) is turned on and sent to the connected mics.

CAUTION

- Confirm that phantom power is OFF before connecting a line level device to a **EXT MIC/LINE IN** jack. If you connect a line level device while phantom power is being supplied, that device and this unit could be damaged.
- When using a condenser microphone, before connecting to and disconnecting from a **EXT MIC/LINE IN** jack, confirm that the phantom power for that jack is OFF. If you connect or disconnect a mic while phantom power is being supplied, that mic and this unit could be damaged.
- Turn phantom power ON only when using a condenser microphone that requires phantom power.
- Supplying phantom power to some types of ribbon microphones could break them. Do not supply phantom power to a ribbon microphone if you are in doubt.
- When using USB bus power, the unit might not be able to supply phantom power depending on the computer. In this case, use a TASCAM PS-P515U AC adaptor (sold separately).
- Some condenser microphones will not operate when phantom power is set to +24V.

- Do not connect or disconnect the AC adaptor when using phantom power. Doing so could damage this device.

Adjusting the input level

Before starting recording, the input level should be adjusted to prevent the recorded sounds or signals from being distorted due to excessively large input signals or from being inaudible due to excessively low input signals compared to noise.

In addition to manual adjustment, the unit has the following three level adjustment functions: peak reduction, automatic level control, and limiter. Any of these can be used as required.

TIP

In addition to adjusting the INPUT level, try changing the distance and angle between the microphone and the sound source. The angle and distance of the microphone can also change the character of the recorded sound.

Manually adjusting the input level

The following procedures explain how to use the Record Screen to set the levels.

CAUTION

Manual adjustment cannot be performed when the automatic level control mode is selected as a level control function (**AUTO** appears to the right of the elapsed time on the recording screen). To enable manual input level adjustment, select **OFF** or other mode in the level control setting screen (see “Using the Level Control Function” on page 50).

1 Press the **RECORD [●]** button to begin recording standby.

The record indicator flashes red and the recording screen appears.



2 Adjust the input level using the **INPUT LEVEL + or -** button on the left side panel.

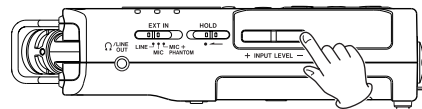

When you press the **INPUT LEVEL + or -** button, a pull-up menu screen appears to indicate the input level setting.

4 – Recording



The **PEAK** indicator to the right of the display lights red when the input level is too high.

A ▼ mark is provided at -12 dB on the level meters. Set the input level so that the indicator bars move to and fro with this mark at about the center without causing the **PEAK** indicator to light red when the loudest sounds occur.

NOTE

- Press the ϕ / I (HOME) [■] button to exit recording standby.
- When in recording standby or during recording, the speaker does not output sound even if the **SPEAKER** setting is enabled. Connect headphones to the Ω /LINE OUT jack if you want to adjust the level or record while monitoring the input. Use the + or – button in the Home Screen to adjust the monitoring volume. This does not affect the sound to be recorded.

Using the Level Control Function

The level control function for recording through a microphone is set as follows.

- 1 Press the **RECORD** [●] button to bring the unit in recording standby. The indicator will flash and the recording screen will appear.
- 2 Press the **QUICK** button.
The Quick menu screen will appear.



- 3 Use the + or – button to select (highlight) **LEVEL CTRL**, and press the **ENTER/MARK** button.
The level control setting screen will appear.



Options: OFF (default), **PEAK REDUCTION**, **AUTO LEVEL**, **LIMITER**

- 4 Use the + or – button to select (highlight) a mode, and press the **ENTER** button to enable the mode and return to the recording screen.
The selected mode is shown with an icon in the recording screen.

PEAK REDUCTION:

The input volume is reduced automatically to an appropriate level when excessively large signals come in. This allows input level setting to be performed easily.

The input level can be raised manually if required.

TIP

When recording live performances, for example, test for peak reduction may be performed before actual recording.

Select the peak reduction mode in recording standby, and maximize the input level.

As a test performance is given subsequently, the input gain for recording is reduced to an appropriate level to meet the input signals, and an optimum input level for the performance is set.

Recording will be stored at this input level if this mode is disabled before starting recording.

Otherwise, the input level will continue to be controlled automatically during recording.

It is also possible to store the recording in the limiter mode after automatically setting the input level in the peak reduction mode.

AUTO LEVEL:

The input level is controlled automatically to increase or decrease the input level when the input signals are too small

or too large, respectively. This mode is useful for recording at meetings. In this mode, the input level cannot be changed manually.

LIMITER:

This prevents distortion of sounds when excessively large input signals come in suddenly.

This mode is also suited for recording of live performances with large volume changes.

In this mode, the input level can be changed manually during recording.

NOTE

- Distortion of sounds may occur when excessively large input signals come in even if the LIMITER function is activated. In such a case, lower the input level or keep proper distance between the unit and the source.
- When using LINE input, the level controls have no effect.

Overview of recording modes

This recorder has five recording modes.

Use the REC MODE item on the REC MODE screen to set the recording mode.

The settings available are different for each recording mode.

4 – Recording

MONO mode

This is a mode for mono recording.

STEREO mode (default)

This is a mode for stereo recording of two independent left and right channels.

DUAL mode

This mode uses one input source (mono or stereo pair) to create two files with different input level settings (LEVEL CTRL setting screen). Either two mono or two stereo recording files are created.

4CH mode

This mode uses both the built-in mics and the external inputs to record two pairs of inputs as two files.

Two stereo recording files are created.

OVERDUB mode

This recording mode add new sounds to the playback file.

There are two types of OVERDUB mode: MIX and SEPARATE.

The MIX OVERDUB mode mixes the playback sound and input sound to create a new file. The SEPARATE OVERDUB mode creates a new recording file with only the input sound.

This mode can be selected from the parameters.

Recording (MONO/STEREO recording)

Make recording settings

- 1 Press the **REC MODE** button to open the **REC MODE** screen.
- 2 Use the **+ or –** button to select **REC MODE**, and press the **ENTER/MARK** or **▶▶** button.
- 3 Use the **+ or –** button to select **MONO** or **STEREO**. (Default: **STEREO**)



Mono recording



Stereo recording

- 4 Press the **◀◀** button to select the other item.
- 5 Use the **+ or –** button to select **SOURCE**, and press the **ENTER/MARK** or **▶▶** button.

6 Use the + or – button to select the input source.

REC MODE	SOURCE (options)	Explanation
MONO	INT MIC MONO (default)	L/R signals of built-in mics are mixed and recorded in mono
	EXT IN 1	L external input is recorded in mono
STEREO	INT MIC ST (default)	Built-in mics are recorded in stereo
	EXT IN 1/2	External inputs are recorded in stereo

7 Press the **◀** button to select the other item.

8 If REC MODE is set to STEREO, you can also set MS mic decoding.

When using MS mics, use the + and – buttons to select the MS DECODE item, and press the ENTER/MARK or **▶▶** button.

Use the + and – buttons to set MS DECODE to ON.

9 Press the **⏪** / **⏩** (HOME) [**■**] button to return to the Home Screen.

Set where to save the file

Set the folder where recorded files are saved. The created sound file will be saved in the currently selected folder. For details, see SELECT popup menu under “Folder operations” on page 72.

If no setting is made, new recording files are placed in the MUSIC folder.

Starting the recording

1 Press the RECORD [**●**] button to begin recording standby.



Mono Recording



Stereo Recording

The screen shows the recording file name, the input source, the recording audio file type and sampling frequency. Please confirm that these are as desired before starting recording.

2 To start recording, press the RECORD [**●**] button again.



Mono Recording



Stereo Recording

When recording starts, the indicator lights continuously, and the display shows the elapsed recording time and the remaining recording time.

4 – Recording

- 3 Press the \odot / | (HOME) [■] button to end recording and create the audio file.

To pause recording, press the RECORD [●] button.

Press the RECORD [●] button again to restart recording in the same file. If you press the \odot / | (HOME) [■] button after pausing a recorded audio file up to the moment that you paused recording is created.

NOTE

To avoid recording of the noise from pressing the RECORD [●] button, the start of recording is delayed by 0.3 second (fixed) after the RECORD [●] button is pressed. (REC DELAY)

CAUTION

Noise may occur when recording with a microphone if the unit is too close to the AC adaptor. In such a case, keep sufficient distance between the AC adaptor and the unit.

File names when recording in MONO/STEREO

TASCAM_0001.WAV

①

②

- ①: Set with the WORD item on the FILE NAME screen
②: Recording file base number

Simultaneously recording two files at different input levels (DUAL REC)

This recorder can simultaneously record a second recording at a different input level along with the regular recording. For example, when recording with microphones, you can make an ordinary recording with the input level set as high as possible and simultaneously record at a slightly lower input level for safety.

Two recorded files (one with higher input level and one with lower input level) are saved individually

NOTE

- Make the input level setting for the ordinary recording in the usual manner (see “Preparing the recording inputs” on page 46 and “Adjusting the input level” on page 49).
- Dual recording and overdubbing cannot be used simultaneously.
- Effects cannot be used on the file recorded at a different input level.

Enabling dual recording

- 1 Press the REC MODE button to open the REC MODE screen.

2 Use the + and – buttons to select **REC MODE**, and press the **ENTER/MARK** or **▶▶|** button.

3 Use the + and – buttons to set it to **DUAL**.

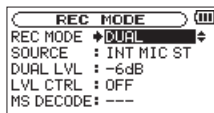

4 Press the **◀◀|** button to return to setting item selection.

5 Use the + and – buttons to select **SOURCE**, and press the **ENTER/MARK** or **▶▶|** button.

6 Use the + and – buttons to set the input source.

SOURCE	Explanation
INT MIC ST (default value)	Stereo recording with built-in mics
INT MIC MONO	L/R signals of built-in mics are mixed and recorded in mono
EXT IN 1	Mono recording with external mics or equipment
EXT IN 1/2	Stereo recording with external mics or equipment

7 Press the **◀◀|** button to return to setting item selection.

8 Use the + and – buttons to select **DUAL LVL**, and press the **ENTER/MARK** or **▶▶|** button.

9 Use the + and – buttons to set the input level of the second file in dual recording.

Setting range: -6dB (default value) to -12dB

10 Press the **◀◀|** button to return to setting item selection.

11 Use the + and – buttons to select **LVL CTRL**, and press the **ENTER/MARK** or **▶▶|** button.

12 Use the + and – buttons to set input level control functions for the second file in dual recording.

LVL CTRL	Explanation
OFF (default value)	No level control
PEAK REDUCTION	If the input sound is too loud, the input level is automatically lowered to a suitable level. This function makes handling difficult input level settings easier. You can still raise the input level manually.
AUTO LVL	Low input levels are raised and high input levels are lowered automatically, making this useful for recording meetings, for example. In this mode, you cannot raise the input level manually.
LIMITER	This prevents distortion if the input level becomes too loud suddenly. This is useful for live performances and other recordings when extreme volume changes occur. In this mode, you can still raise the input level manually even when recording.

4 – Recording

- Press the **◀◀** button to return to setting item selection.
- If using MS mics, use the **+** and **-** buttons to select **MS DECODE**, and press the **ENTER/MARK** or **▶▶** button. Use the **+** and **-** buttons to set **MS DECODE** to **ON** (default value: **OFF**).
- When setting is complete, press the **⏻** / **|** (**HOME**) [**■**] button to return to the Home Screen.

Starting dual recording

Press the **RECORD** [**●**] button to start dual recording.

During dual recording, the recording screen appears as follows.



In the input source display area of the recording screen, the input levels of the current input source and the dual recording are shown.

Dual recording file names

Dual recording allows two files to be recorded simultaneously. The name of the second file created by dual recording has

“DXX” added to the file name of the ordinary recording. “DXX” shows the amount that the input level has been lowered.

TASCAM_0002S12.WAV

① ② ③ ④

TASCAM_0002S34D12.WAV

① ② ③ ④ ⑤

- Set with the **WORD** item on the **FILE NAME** screen
- Recording file base number
- “S” is the source file
- Assigned channels (“12” is channels 1/2 and “34” is channels 3/4)
- This dual recording file was recorded with the input level set to -12 dB. (This would be “D06” if recorded at -6 dB or “D10” if recorded at -10 dB, for example.)

NOTE

- If the input level is less than -24 dB, dual recording might not have the expected result.
- If **LVL CTRL** is set to **AUTO LVL** or **PEAK REDUCTION**, then the **DUAL LVL** cannot be changed.

Recording 4 channels

You can use the built-in mics with connected external mics or equipment to record four independent channels as two stereo recording files (channels 1/2 and 3/4).

Making 4-channel recording settings

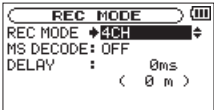
- 1 Press the **REC MODE** button to open the **REC MODE** screen.
 - 2 Use the **+** and **-** buttons to select **REC MODE**, and press the **ENTER/MARK** or **▶▶** button.
 - 3 Use the **+** and **-** buttons to set it to **4CH**.
- 
- 4 Press the **◀◀** button to return to setting item selection.
 - 5 When using **MS** mics, use the **+** and **-** buttons to select **MS DECODE**, and press the **ENTER/MARK** or **▶▶** button. Use the **+** and **-** buttons to set **MS DECODE** to **ON**.
 - 6 Press the **◀◀** button to return to setting item selection.

7 Use the **+** and **-** buttons to select **DELAY**, and press the **ENTER/MARK** or **▶▶** button.

8 Use the **+** and **-** buttons to set the value according to the distance between the built-in mics and external mics.

Options: **INT 30ms (10m) – EXT 30ms (10m)** (default value: **0ms (0m)**)

The values are in milliseconds (ms) and meters (m).

NOTE

- If the built-in mics (channels 1/2) are far apart from the external mics (channels 3/4), a time delay will occur in recording. Use the **DELAY** setting to eliminate this time delay in recording.
 - If the sound source is closer to the built-in mics, use an **INT XXms (XXm)** setting according to the difference in distance to the external mics.
 - If the sound source is closer to the external mics, use an **EXT XXms (XXm)** setting according to the distance to the built-in mics.
- 9 When setting is complete, press the **⏻ / | (HOME) [■]** button to return to the Home Screen.

4 – Recording

Starting 4-channel recording

- 1 Press the RECORD [●] button to begin recording standby.



NOTE

Before you start recording you can confirm the recording audio file format and sampling frequency at the top of the recording screen, as well as the input sources on the left and the recording project name beneath the meter bars.

- 2 Press the RECORD [●] button again to start recording.



File names when recording in 4-channel

4-channel recording creates two files simultaneously.

Two files – one for the built-in mics (channels 1/2) and one for the external mics or equipment (channels 3/4) – are created as a set.

TASCAM_0002S12.WAV

① ② ③ ④

TASCAM_0002S34.WAV

① ② ③ ④

- ①: Set with the WORD item on the FILE NAME screen
- ②: Recording file base number
- ③: “S” is the source file
- ④: Assigned channels (“12” is channels 1/2 and “34” is channels 3/4)

Recording playback and input sounds together (overdubbing)

Overdubbing has two modes.

Using the overdubbing function, you can mix input signals with an audio file that is played back and record either the combined signals or just the input signal as a new file.

NOTE

- In OVERDUB mode, the pre-recording and auto-recording functions are disabled.
- In OVERDUB mode, you cannot start new files manually.
- You cannot pause in OVERDUB mode. (You cannot use the RECORD [●] button.)

- In OVERDUB mode, the recording format and sampling frequency used are the same as those of the playback file regardless of the settings.
- Overdubbing and dual recording cannot be used simultaneously.
- In OVERDUB mode, you cannot use the MS decoder.
- If the playback file is a mono file, the recording file will also be mono.
- If the playback files are two 96 kHz WAV/BWF or two MP3 format files, recording cannot be conducted in MIX mode. Mix them down to one file and then OVERDUB again (see “Mixdown” on page 91).
- If the playback file is mono, SEPARATE mode cannot be used for recording. In this case, use MIX mode.

Setting the overdubbing mode

- 1 Press the **REC MODE** button to open the REC MODE screen.
- 2 Use the + and – buttons to select REC MODE, and press the **ENTER/MARK** or **▶▶|** button.
- 3 Use the + and – buttons to set it to OVERDUB.

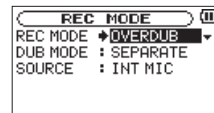

- 4 Press the **◀◀** button to return to setting item selection.
- 5 Use the + and – buttons to select DUB MODE, and press the **ENTER/MARK** or **▶▶|** button.
- 6 Use the + and – buttons to set the overdubbing mode.

DUB MODE	Explanation
MIX	The playback signals of the files on channels 1/2 and 3/4 and the input signals are mixed and recorded as a new file. The playback file will not be overwritten.
SEPARATE (default value)	The file on channels 1/2 is played back and a new file is recorded on channels 3/4. The playback signals of channels 1/2 are not recorded. The playback file will not be overwritten.

NOTE

- When a file is recorded using SEPARATE mode, the playback signal is not included in the recording.
- Since a recording made in SEPARATE mode does not include the playback signal, you can record again with the same playback file as many times as you want. You can then

4 – Recording

listen to and select the best one from multiple recordings afterward.

- Press the **◀◀** button to return to setting item selection.
- Use the **+** and **-** buttons to select **SOURCE**, and press the **ENTER/MARK** or **▶▶** button.
- Use the **+** and **-** buttons to set the input source.

SOURCE	Explanation
INT MIC (default value)	Record using built-in mics.
EXT IN 1	Record using external inputs. When creating a stereo file, the same sound is added to both L/R channels.
EXT IN 1/2	Record using external inputs. When creating a mono recording, the L channel is recorded.

- Press the **◀◀** button to return to setting item selection.
- When setting is complete, press the **⏻** / **| (HOME)** [**■**] button to return to the Home Screen.

Select the file you want to overdub

Use the **◀◀** and **▶▶** buttons and the **BROWSE** screen to select that files that you want to overdub.

NOTE

See "Working with Files and Folders (BROWSE Screen)" on page 69 for selecting files using the **BROWSE** screen.

Start the overdubbing

- Press the **RECORD** [**●**] button to set the unit to record standby.



MIX recording

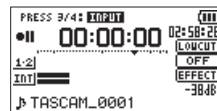

Separate recording

When in MIX mode, press the **1/2 [SOLO]** button to mute monitoring of the input sound.

When in SEPARATE mode, if there are two playback files, press the **3/4 [SOLO]** button to switch between the input sound and the playback file. If there is only one file, this mutes the input sound.

- Press the **RECORD** [**●**] button to start overdubbing.



MIX recording

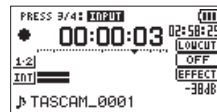

Separate recording

When recording starts, the indicator lights and the display shows the elapsed and remaining recording times.

The following error message appears if the selected file cannot be played back.



3 To stop recording, press the ⏏ / | (HOME) [■] button.

File names when recording in overdubbing

When overdubbing, file names are generated differently according to the DUB mode setting.

■ SEPARATE mode

Playback file

File-A: TASCAM_0004S12.WAV
 ① ② ③ ④

The newly recorded file (recorded without the playback signal)

File-B: TASCAM_0004S34.WAV
 ① ② ③ ④

If you record again using the same playback file (File-A), the name of File-B above is changed to the file name below (File-C), and the new recording file is given the File-B file name.

File-C: TASCAM_0004V34t1.WAV
 ① ② ③ ④ ⑥

If you record one more time using the same playback file (File-A) (and File-B and File-C above are saved), the file name for File-B changes as shown below, with the number at ⑥ increased by one, and the new recording file given the File-B file name.

File-D: TASCAM_0004V34t2.WAV
 ① ② ③ ④ ⑥

■ MIX mode

Playback file

File-A: TASCAM_0004S12.WAV
 ① ② ③ ④

The newly recorded file (recorded with the playback signal (File-A))

File-E: TASCAM_0005S12.WAV
 ① ② ③ ④

4 – Recording

If you record again using the same playback file (File-A), the file name of the new recording will be as follows.

File-F: TASCAM_0006S12.WAV
① ② ③ ④

In this mode, each time you record with the same playback file, the number in item ② increases by one for the name of each new file.

- ①: Set with the WORD item on the FILE NAME screen
- ②: Recording file base number
- ③: "S" is the source file and "V" is the virtual file
- ④: Assigned channels ("12" is channels 1/2 and "34" is channels 3/4)
- ⑥: Backup number in the virtual file

NOTE

- In OVERDUB SEPARATE mode, the base number of the recording file and "S12" are added to the file name of the playback file.
- If writing files copied from elsewhere is not possible, enable writing using a computer, for example.

Recording automatically (AUTO REC)

This function allows the unit to respond to input sound levels and start and pause recording, as well as set marks and create new files, for example.

- 1 Press **MENU** to open the MENU Screen.
- 2 Use the **+ or -** button to select REC SETTING, and press the **ENTER/MARK** or **▶▶|** button.

REC SETTING screen appears.

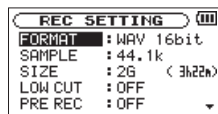

- 3 Use the **+ or -** button to select the MODE and press the **ENTER/MARK** button or **▶▶|** button.
- 4 Use the **+ or -** button to set the MODE of the AUTO REC setting.

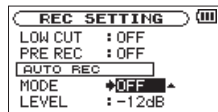

OFF(Default): Off

REC: Records and pauses automatically

MARK: Sets marks automatically during recording

- 5 Press the **◀◀** button to select the other item.
- 6 Use the **+** or **-** button to select LEVEL and press the **ENTER/MARK** button or **▶▶** button.

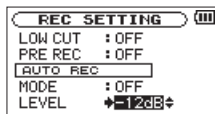

- 7 Use the **+** or **-** button to select the level that signal is judged to have been input when it exceeds this level. Set the value to one of the following selection.

-6dB/-12dB (default)/-24dB/-48dB

- 8 Press the **⏪** / **(HOME)** [■] button to return to the Home Screen.
- 9 Press the **RECORD** [●] button to put the unit into recording standby.

Recording starts automatically when the input signal exceeds the LEVEL.

- 10 The recording mode changes according to the setting of the MODE.

REC:

If the input signal level falls below the standard level for more than five seconds, which is set on LEVEL, the unit goes into recording standby. When the input signal level becomes higher than the standard level, the unit restarts recording on a new file.

MARK:

If the input signal level falls below the standard level for more than five seconds, which is set on LEVEL, the unit adds marks when the input signal level becomes higher than the standard level again.

- 11 Press the **⏪** / **(HOME)** [■] button to stop automatic recording.

TIP

By using this in combination with the PRE REC function, you can record events without losing the beginnings of sounds.

CAUTION

- Auto-recording does not work in OVERDUB mode.
- When the auto-recording function is on, unless overridden by overdubbing mode, the self-timer cannot be used.

Creating and changeover to a new file during continued recording (Track increment)

You can manually or automatically split a recording by creating a new file. (Track increment)

4 – Recording

Manual track increment during recording

You can manually split a recording by creating a new file.

Press the **▶▶|** button while recording.

NOTE

- When new files are created, incremental numbers are added to the end of each project name.
- A new file cannot be created if the total number of files and folders would exceed 5000.
- Files shorter than two seconds cannot be created. If the sampling frequency is 96 kHz, files shorter than four seconds cannot be created.
- If the name of a newly created file would be the same as that of an existing file, the number will be incremented until the new file has a unique name.
- Track increment is not possible in OVERDUB mode.

Automatic track increment by file size

Without pausing recording, a new file can be created automatically during recording when a file size set in advance is exceeded.

- 1 Press the **MENU** button to open the **MENU** Screen.
- 2 Use the **+ or –** button to select **REC SETTING**, and press the **ENTER/MARK or ▶▶|** button.
REC SETTING screen appears.

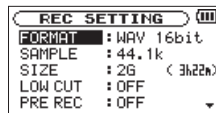

- 3 Use the **+ or –** button to select **SIZE**, and press the **ENTER/MARK or ▶▶|** button.

Use the **+ or –** button to set the maximum file size at which track increment takes place, by selecting (highlighting) from the following:

64M/128M/256M/512 M/1G/2G (default)

- 4 Press the **⏻ / | (HOME) [■]** button to return to the Home Screen.

NOTE

- A new file cannot be created if the total number of files and folders would exceed 5000.
- For the same file size, the possible recording time differs depending on the file type selected. Furthermore, if the recording time is 24 hours or more, this will be displayed as 23:59:59.

Mark function

Adding marks manually to a recording

You can manually add marks to a recording where you want them.

Press the ENTER/MARK button while recording to add a mark.

Mark number pull-up appears.



NOTE

- Mark information is stored in the file with numbers between 01–99. The maximum number of marks in a file is 99.
- As the unit is compatible with the BWF format for WAV files, marks added to a WAV file during recording are stored in the file. Marks stored in the file are available when playing back the file using a BWF compliant software, etc.
- When using the built-in mics, the sound of pressing the button when adding a mark could be recorded. To avoid this, use a remote control to add marks.

Adding marks automatically to a recording

This function allows the unit to add marks automatically using AUTO REC.

On the REC SETTING screen, set the AUTO REC section MODE item to MARK.



See “Recording automatically (AUTO REC)” on page 62.

Moving to a mark position

You can move to marks in the currently selected file when stopped and during playback.

You can use this function to identify points to create shortcuts to the beginning of songs, for example.

Press the ◀◀ or ▶▶ button while pressing and holding the ENTER/MARK button during playback or when stopped.

NOTE

You cannot move to a mark in a different file.

4 – Recording

Setting the low cut filter

The low cut filter can reduce noise such as offensive wind noise from air-conditioners and projectors.

- 1 Press the **MENU** button to open the **MENU** Screen.
- 2 Use the **+ or –** button to select **REC SETTING**, and press the **ENTER/MARK** or **▶▶▶** button.
REC SETTING screen appears.
- 3 Use the **+ or –** button to select **LOW CUT**, and press the **ENTER/MARK** or **▶▶▶** button.

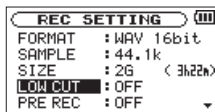

- 4 Use the **+ or –** button to select the cut off frequency of the low cut filter for mic input.

Options: OFF (default), 40Hz, 80Hz, 120Hz

CAUTION

- When an external input is selected, the low-cut filter cannot be used.
- Use headphones to monitor when you are recording with a microphone. If you use speakers to monitor, the sound output from the speakers may also be recorded, causing a poor recording and even feedback.

NOTE

LOW CUT can be set when recording/in recording standby.

TIP

Use the built-in effects of this unit as necessary on the input source. (See “Using the Effects” on page 92.)

Recording the moment before pushing RECORD (PRE REC)

By using prerecording, when the unit is in recording standby you can record up to two seconds of the signal input before the **RECORD [●]** button is pushed to start recording.

- 1 Press the **MENU** button to open the **MENU** screen.
- 2 Use the **+ or –** button to select **REC SETTING**, and press the **ENTER/MARK** or **▶▶▶** button.
- 3 Use the **+ or –** button to select **PRE REC**, and press the **ENTER/MARK** or **▶▶▶** button.
- 4 Use the **+ or –** button to select **ON**.
(Default: OFF)

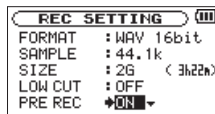

- 5 Press the **⏪ / | (HOME) [■]** button to return to the Home Screen.

TIP

By using this in combination with the AUTO REC function, you can record events without losing the beginnings of sounds.

NOTE

- If the amount of time in record standby is less than two seconds, the sound for that amount of time is recorded.
- The prerecording function is disabled in OVERDUB mode.

Self-timer function

Like a camera, the unit has a self-timer to trigger the start of recording after a set period of time.

- 1 Press **RECORD [●]** button when stopped or playing back to set the unit in recording standby, and press the **PB CONT** button.
- 2 The self-timer icon  appears in the recorder status screen, and time is shown on the right. Each time you press the **PB CONT** button, the setting changes as follows:
OFF (default) → 5S (5 seconds) → 10S (10 seconds) → OFF



- 3 Set the time period, and press the **RECORD [●]** or **PLAY [▶]** button.

Recording will start after the set time period.

NOTE

- This function cannot be used when recording is paused in the middle of recording.
- Self-timer function is not possible when using the AUTO REC function.

Solo function

Press and hold the **1/2 [SOLO]** or **3/4 [SOLO]** button to enable the solo function.

Use this in 4-channel mode and other cases when multiple inputs are being recorded to monitor only one of the inputs. You can check the solo status with the input source icons.

4 – Recording

Recording duration

The table below shows the maximum recording time on SD/SDHC cards of different capacities for different file formats for recording.

File format (recording setting)			SD/SDHC card capacity (hours:minutes)			
			1 GB	2 GB	4 GB	8 GB
WAV/BWF (stereo)	16 bit	44.1 kHz	1:41	3:22	6:44	13:28
		48 kHz	1:33	3:06	6:12	12:24
		96 kHz	0:46	1:33	3:06	6:12
	24 bit	44.1 kHz	1:07	2:15	4:30	9:00
		48 kHz	1:02	2:04	4:08	8:16
		96 kHz	0:31	1:02	2:04	4:08
MP3 (stereo/ mono)	32 kbps	44.1 kHz/48 kHz	74:32	149:04	298:08	596:16
	64 kbps	44.1 kHz/48 kHz	37:16	72:32	149:04	298:08
	96 kbps	44.1 kHz/48 kHz	24:50	49:40	99:20	198:40
	128 kbps	44.1 kHz/48 kHz	18:38	37:16	74:32	149:04
	192 kbps	44.1 kHz/48 kHz	12:25	24:50	49:40	99:20
	256 kbps	44.1 kHz/48 kHz	9:19	18:37	37:16	74:32
	320 kbps	44.1 kHz/48 kHz	7:27	14:54	29:48	59:36

- The recording times shown above are estimates. They might differ depending on the SD/SDHC card in use.
- The recording times shown above are not continuous recording times, but rather they are the total possible recording times for the SD/SDHC card.
- If recorded in mono in WAV files, the maximum recording time will be double the figures above.
- For dual and 4-channel recording in WAV/BWF format, the recording times are about half those shown above.

5 – Working with Files and Folders (BROWSE screen)

On the **BROWSE** Screen, you can view the contents of the Music Folder, which contains the audio files on the SD card that you can use with the DR-40. On this screen, you can also play and erase selected audio files, create folders, add files to the playlist and so on. (See “Playlist” on page 77.)

TIP

If you connect the DR-40 with a computer by USB, or mount the SD card on a computer using a card reader or other input, you can change the folder structure within the **MUSIC** Folder and erase files from the computer as you would the contents of a hard drive. Furthermore, you can change file names from the computer.

To open the **BROWSE** Screen, press the **MENU** button to open the **MENU** screen. Use the + or – button to select **BROWSE** and press the **ENTER/MARK** or ►► button.



The contents of the folder that contains the file that was selected on the Home Screen before the **BROWSE** Screen was opened appears on the display.

Screen navigation

On the **BROWSE** Screen, folders and music files appear in a hierarchical structure much like they would appear on a computer. On the DR-40, folders can only be used to two levels.

- Use the + or – button to select files and folders.
- When a folder is selected, press the ►► button to show the contents of that folder.
- When a file or folder is selected, press the ◀◀ button to exit the currently open folder and go to a higher level in the folder structure.
- When a file or folder is selected, press the **QUICK** button to open the pop-up window.
- When a file is selected, press the **ENTER/MARK** or ►► button to return to the Home Screen and play the file. This folder that contains this file becomes the current folder, and new recorded file will be saved in this folder. If the playback area has been set to **FOLDER**, this folder becomes the new playback area.
- When a folder is selected, press the **ENTER/MARK** button to return to the Home Screen. The first file in the folder (shown at the top of the file list) will be played. This folder becomes the current folder, and new recorded files will be saved in this folder. Regardless of the previous

5 – Working with Files and Folders (BROWSE screen)

setting, the playback area is set to FOLDER, and this folder becomes the new playback area.

Icons on the BROWSE screen

The meanings of icons that appear on the BROWSE Screen are as follows.

Root Music Folder (MUSIC)

The MUSIC Folder is the highest (root) level folder in the hierarchy shown on the BROWSE Screen.

Audio file

This icon appears before the names of music files.

Plus folder

This icon shows folders that contain subfolders.

Plain folder

This icon shows folders that do not contain subfolders.

Open folder

The contents of the folder marked with this icon currently appear on this screen.

File operations

Select the desired audio file on the BROWSE Screen and press the **QUICK** button to open the pop-up window that is shown below.



Use the + or – button to select the item you want from the following list and press **ENTER/MARK** button to execute it.

INFO

Information (date/time, size) about the selected file appears. Press the **ENTER/MARK** button again or press **the ⏪ / | (HOME) [■]** button to return to the BROWSE screen.

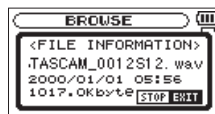

ADD LIST

Adds the selected file to the playlist. (See “Playlist” on page 77.)

5 – Working with Files and Folders (BROWSE screen)

FILE SWAP

Files recorded during the following recording modes can be swapped.

4CH mode:

A file recorded by the built-in mics (channels 1/2) can be swapped with a file recorded by external mics or equipment (channels 3/4).

Example:

TASCAM_0002S12.WAV → TASCAM_0002S34.WAV

TASCAM_0002S34.WAV → TASCAM_0002S12.WAV

OVERDUB SEPARATE mode:

[1] The playback file and a newly recorded file can be swapped.

Example:

TASCAM_0004S12.WAV → TASCAM_0004S34.WAV

TASCAM_0004S34.WAV → TASCAM_0004S12.WAV

The above is the same as swapping File-A and File-B as described on page 61.

[2] A newly recorded file and a virtual file saved based on it can be swapped.

Example:

TASCAM_0004S34.WAV → TASCAM_0004V34t1.WAV

TASCAM_0004V34t1.WAV → TASCAM_0004S34.WAV

The above is the same as swapping File-B and File-C as described on page 61. In addition, since you can choose the virtual file freely when swapping the above, you can also swap File-B and File-D as on page 61.

However, you cannot swap two virtual files (for example, File-C and File-D as on page 61).

FILE DELETE

A message appears to confirm that you want to delete the file. Press the **ENTER/MARK** button to erase the file and the **⏪ / | (HOME)** [**■**] button to cancel the deletion operation.



PROJECT DEL

A pop-up message appears confirming that you want to erase the project containing the selected file.

Press the **ENTER/MARK** button for each project to erase. Press the **⏪ / | (HOME)** [**■**] button to cancel deletion.



5 – Working with Files and Folders (BROWSE screen)

CAUTION

This deletes all the files in the selected project.

CANCEL

The operation for the selected (highlighted) file is canceled, and the pop-up menu is closed.

NOTE

The pop-up menu can also be closed by pressing the **QUICK** button.

Folder operations

Select the desired folder on the **BROWSE** Screen and press the **QUICK** button to open the pop-up window that is shown below.

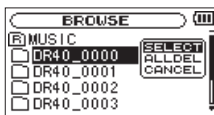

Use the + or – button to select the item you want from the following list and press the **ENTER/MARK** button to execute it.

SELECT

Returns to the Home Screen and selects the first file in the folder. Regardless of the previous setting, the playback area is set to **FOLDER**, and this folder becomes the new playback area. When recording, files are created in this folder.

ALL DEL

A pop-up message appears to confirm that you want to delete all the files in the selected folder at once.

Press the **ENTER/MARK** button to erase the files or press the **⏪ / | (HOME) [■]** button to cancel.



NOTE

You cannot erase read-only files and files that are not recognized by this unit.

CANCEL

The operation for the selected (highlighted) file is canceled, and the pop-up menu is closed.

NOTE

The pop-up menu can also be closed by pressing the **QUICK** button.

5 – Working with Files and Folders (BROWSE screen)

Creating a new folder

In the file list, **NEW FOLDER** appears at the bottom.

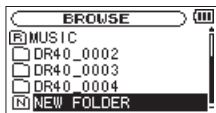

Select (highlight) **NEW FOLDER**, and press the **ENTER/MARK** or **▶▶** button. A pop-up appears to confirm that you want to create a new folder.



Press the **ENTER/MARK** button to create a new folder or press the **⏪ / [HOME] [■]** button to cancel.

Note that the unit supports only a two-level folder structure, and accordingly **NEW FOLDER** does not exist in the second-level folders.

A newly created folder becomes the current one, and new recorded files are saved in this folder. If the playback area has been set to **FOLDER**, this folder becomes the playback area.

6 – Playback

On the Home Screen, you can use the ◀◀ and ▶▶ buttons to select the playback file. The files that you can select are determined by the playback area setting.

Limiting the playback area makes file selection easier when you have numerous recorded and copied files on the SD card.

On the PLAY SETTING Screen, you can select all files, the current folder or the playlist as the playback area. You can also use the BROWSE Screen to set a folder as the playback area.

TIP

On the BROWSE Screen, regardless of the playback area setting, you can select any file on the card that you want.

Adjusting playback volume

The volume of output through the built-in speaker or the ◻/LINE OUT connector can be adjusted using the + or – button while the Home Screen is shown.

A pull-up volume indicator appears.



Setting the playback area (AREA)

Set the playback area for repeat and ordinary playback on the PLAY SETTING screen.

- 1 Press the MENU button to open the MENU Screen.
- 2 Use the + or – button to select PLAY SETTING and press the ENTER/MARK or ▶▶ button.

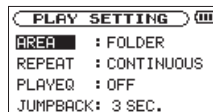

- 3 Use the + or – button to select (highlight) AREA, and press the ENTER/MARK or ▶▶ button.

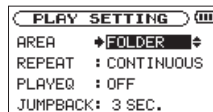

- 4 Use the + or – button to set the playback area.
ALL FILES

Set the playback area as all files in the Music Folder on the SD card.

FOLDER (default)

Set the playback area as all the files in the currently selected folder.

PLAYLIST

Set the playback area as the files in the playlist. (See “Playlist” on page 77.)

If there is no playlist defined, a No PLAYLIST pop-up appears.



- 5 Press the \odot / $|$ (HOME) [■] button to return to the Home Screen.

NOTE

The current playback area setting appears in the upper left of the Home Screen.

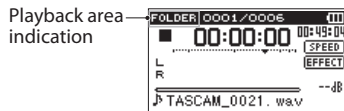

Selecting a folder for the playback area (1)

Regardless of the current playback area, if you select a folder on the BROWSE Screen, the playback area changes to the selected folder.

- 1 Press the MENU button to open the MENU screen.
- 2 Use the + or – button to select BROWSE, and press the ENTER/MARK or \ggg button.

BROWSE screen appears.

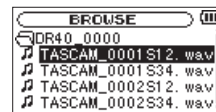

A file list of the folder that contains the file selected in the Home Screen is displayed.

- 3 Use the \lll or \ggg button to select a folder level, and use the + or – button to select a folder.

For an explanation of how to use the Browse Screen, see “Screen navigation” on page 69.

- 4 Press the QUICK button to open the following pop-up window.

6 – Playback

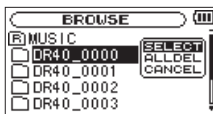

- 5 Use the + or – button to select SELECT, and press the ENTER/MARK button.

The display returns to the Home Screen. The first file in the folder is selected, and the unit is stopped.

Regardless of the previous setting, the playback area is set to FOLDER, and this folder becomes the playback area. This folder becomes the current folder, and new recorded files will be saved in this folder.

Selecting a folder for the playback area (2)

When the playback area is set to FOLDER, if you select a file on the BROWSE Screen, the folder that contains the selected file becomes the playback area.

- 1 Press the MENU button to open the MENU screen.
- 2 Use the + or – button to select BROWSE, and press the ENTER/MARK or ►► button.
BROWSE screen appears.

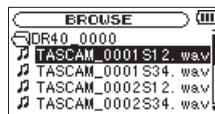

A file list of the folder that contains the file selected in the Home Screen is displayed.

- 3 Use the ◀◀ or ►► button to select a folder level, and use the + or – button to select the folder that contains the file you want to play.

For an explanation of how to use the BROWSE Screen, see “Screen navigation” on page 69.

- 4 Press the ►► button.
- 5 Use the + or – button to select the desired file.

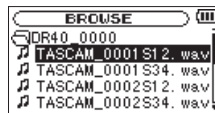

- 6 Press the ENTER/MARK or ►► button.

The display returns to the Home Screen, and the selected file starts playing.

This folder becomes the current folder, and new recorded files will be saved in this folder. In addition, the folder that contains this file becomes the playback area regardless of the playback area folder set previously.

Playlist

You can make a list of files for playback (playlist). On the PLAY SETTING Screen if you select PLAYLIST for the AREA item, you can set playback to just the files in your playlist.

Adding files to the playlist

- 1 Press the MENU button to open the MENU screen.
- 2 Use the + or – button to select BROWSE, and press the ENTER/MARK or ►► button.

BROWSE screen appears.

NOTE

For an explanation of how to use the BROWSE Screen, see “Screen navigation” on page 69.

- 3 Use the + or – button to select the file you want to add to the playlist, and press the QUICK button.

NOTE

For details about how to select the file, see “Screen navigation” on page 69.

A pop-up window appears.

- 4 Use the + or – button to select ADD LIST.



- 5 Press the ENTER/MARK button.

The file is added to the playlist and the popup window closes.

- 6 Repeat steps 3, 4, and 5 as necessary to add more files to the playlist. The files are numbered in the order that they are added.

Editing the playlist

You can view and edit the playlist you have made on the PLAYLIST screen.

You can also use this screen to play files and to edit the playlist.

- 1 Press the MENU button to open the MENU screen.
- 2 Use the + or – button to select BROWSE, and press the ENTER/MARK or ►► button.

BROWSE screen appears.

- 3 Use the ◀◀ button to move to the top folder level.

6 – Playback



- 4 Use the + or – button to select **PLAYLIST**, and press the ►► button.

PLAYLIST screen appears.

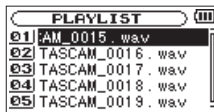

- 5 Use the + or – button to select the file you want to edit, and press the QUICK button.

A pop-up window appears.

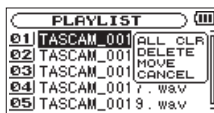

- 6 Use the + or – button to select an item, and press the ENTER/MARK button to cause the unit to work as follows.

ALL CLR

A confirmation message appears to confirm that you want to remove all the files from the playlist. Press the **ENTER/MARK** button to remove all the files or the **⏪ / |(HOME) [■]** button to cancel this operation.

For this operation, it does not matter which file you select in step 5. All the files are removed from the playlist, but they are not erased from the SD card.



DELETE

Remove the selected file from the playlist.

The file is removed from the playlist, but it is not erased from the SD card.

MOVE

Select this to change the order of files in the playlist.

In addition to the file name, the file number also appears highlighted in inverse.

- Use the + or – button to move the selected file to a different position in the playlist.



In the above example, the 4th file has been moved to the 3rd file position.

- Press the **ENTER/MARK** button.
The display returns to the PLAYLIST screen.

CANCEL

The operation for the selected file is canceled.

Selecting files for playback (skip)

When the Home Screen is open, press the **I◀◀** and **▶▶I** buttons to select the file for playback.

If you press the **I◀◀** button when the playback position is located at the middle of a file, it will return to the beginning of that file. If you press the **I◀◀** button when located at the beginning of a file, the playback position will skip to the beginning of the previous file.

If you press the **▶▶I** button when located at the beginning of or middle of a file, the playback position will skip to the beginning of the next file.

NOTE

- Only files in the playback area that is currently set can be selected for playback.
- The track name, file number and other file information for the currently playing file appear on the display.
- The **■** icon appears on the display when playback is stopped at the beginning of a file, and the **▬▬** icon appears when playback is stopped in the middle of a file (paused).
- When the IN and OUT points are set in the file, pressing the **I◀◀** or **▶▶I** button skips to those points. Press the button repeatedly until the file you want is selected.

Playback

When the Home Screen is open and playback is stopped, press the PLAY [▶] button to start playback.

NOTE

- Files in the playback area can be played.
- You can also choose files for playback by name on the **BROWSE** screen.

6 – Playback

Pausing

When the Home Screen is open and a file is playing back, press the $\odot / |$ (HOME) [■] button to pause playback at the current position. (PAUSE)

Press the PLAY [▶] button again to restart playback from that position.

Stopping

When the Home Screen is open and a file is playing back, press the $\odot / |$ (HOME) [■] button to pause playback, and press the $\odot / |$ (HOME) [■] button to return to the beginning of the file. (STOP)

Rewinding and fast-forwarding (search)

When the Home Screen is open and a file is playing back or stopped, press and hold the \lll or \ggg button to rewind or fast-forward and search the playback file.

NOTE

Press and hold the \lll or \ggg button to accelerate the search speed.

Repeat playback (REPEAT)

You can repeatedly playback one file or multiple files within a designated area.

- 1 Press the MENU button to open the MENU screen.
- 2 Use the + or – button to select PLAY SETTING, and press the ENTER/MARK or \ggg button.
PLAY SETTING screen appears.
- 3 Use the + or – button to select REPEAT, and press the ENTER/MARK or \ggg button.

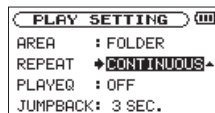

- 4 Use the + or – button to select a repeat mode.
CONTINUOUS (default):

All files in the playback area are played in sequence one time. (This setting is the ordinary playback mode.)

SINGLE:

The selected file is played once without repeating. The $\frac{1}{4}$ icon appears on the Home Screen.

1 REPEAT:

The current file is played repeatedly. The  icon appears on the Home Screen.

ALL REPEAT:

All files in the selected playback area are played back repeatedly. The  icon appears on the Home Screen.

NOTE

If you start loop playback, the repeat operation automatically switches to CONTINUOUS if it is in SINGLE, 1 REPEAT, or ALL REPEAT mode.

- 5 Press the  /  (HOME) [] button to return to the Home Screen.**

Special Playback Control Functions

The unit has some special playback control functions. For example, you can playback a selected section of a file repeatedly or change the tempo of music without changing the pitch. You can also enhance the perceived overall sound pressure for comfortable listening when the playback is indiscernible.

These playback control functions serve for effective practice on musical instruments and analysis of musical passages.



Playback Control Screen

Use the Playback Control screen to set the playback control functions.

While the Home Screen is open when stopped or playing back, press the **PB CONT** button to open the Playback Control screen.



This screen can be used to make settings for the playback speed and loop playback.

After you finish making settings on this screen, press the  /  (HOME) [] button (or press the **PB CONT** button) to return to the Home Screen.



6 – Playback

Repeated Playback of Selection (Loop Playback)



With this function, you can continuously repeat (loop) the playback of a selection that you make.

- 1 While the Home Screen is open when stopped or playing back, press the PB CONT button to open the Playback Control screen.



- 2 Press the PLAY [▶] button to start playback, and press the ENTER/MARK button at the start point of the section that you want to play repeatedly. This position is set as IN (start) point. Then,  appears at the corresponding point on the playback indicator bar.
- 3 Press the ENTER/MARK button at the end point of the section that you want to play repeatedly. This position is set as OUT (end) point. Then,  appears at the corresponding point on the playback indicator bar. Loop playback of the section between the IN and OUT points starts.

During loop playback the  indicator also appears.

Press the PB CONT button to return to the Home Screen while maintaining the I/O and loop settings effective. Even after returning to the Home Screen, the  icon continue to be shown, along with the  and  marks shown at the points corresponding to the IN and OUT points on the playback indicator bar.



NOTE

- The pop-up message of I/O Too Short appears if the section between the IN and OUT points is too short. Set them again. The section should be 1 second or longer.
- Press the **ENTER/MARK** button again to clear the IN and OUT points.
- To stop loop playback, press the **MENU** button when the Playback Control screen is open. Press the **MENU** button again to start loop playback between the set IN and OUT points.
- You cannot set the IN and OUT points in different files.
- The previous IN and OUT point settings are lost when you set the IN point on a different file.

- Accurate assignment of IN and OUT points is not always possible for variable bit rate (VBR) MP3 files.

Changing the playback speed (VSA)

The unit features the VSA (Variable Speed Audition) function that changes the playback speed without changing its pitch.

NOTE

VSA function cannot be used when a file that was recorded at 96 kHz sampling frequency or a file that was recorded in a mode other than MONO/STEREO or OVERDUB/MIX is selected. However, **SPEED** will be shown in the Home Screen and the setting of playback speed can be changed. To apply the adjustment of playback speed, select a file recorded with a sampling frequency of 44.1 kHz or 48 kHz by using the **◀◀** or **▶▶** button.

Press the + or – button after opening the Playback Control screen to increase or decrease the playback speed.



The VSA function can change the playback speed in the range from 0.5 (50%) to 1.5 (150%) times (in 0.1 increments) the normal speed.

Press the **PB CONT** button to return to the Home Screen while maintaining the set playback speed effective. The **SPEED** or **SPEED** icon appears if the playback speed is set to a value larger or smaller than 1.0, respectively.

Using the playback equalizer (PLAY EQ)

You can choose from different sound types to enhance the listenability (PLAY EQ: playback equalizer).

Set the playback equalizer in the **PLAY SETTING** screen.

- 1 Press the **MENU** button to open the **MENU** screen.
- 2 Use the + or – button to select **PLAY SETTING**, and press the **ENTER/MARK** or **▶▶** button. **PLAY SETTING** screen appears.
- 3 Use the + or – button to select **PLAY EQ**, and press the **ENTER/MARK** or **▶▶** button.

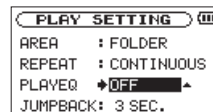

6 – Playback

- Use the + or – button to set the equalizer. TREBLE, MIDDLE, and BASS indicate that adjustment in the high, middle, or low frequency range is enabled, and + and – indicate that the sound level in that range is increased or decreased, respectively.

Options: OFF (factory setting), TREBLE +, TREBLE –, MIDDLE +, MIDDLE –, BASS +, BASS –

- When finished, press the ϕ / | (HOME) [■] button to return to the Home Screen.

Moving back a few seconds for replay (jump-back playback)

Press the **PLAY** [▶] button during playback to move back a few seconds (adjustable) and restart playback. (Jump-back playback).

If you find a favorite passage of music or lyrics during playback, press the **PLAY** [▶] button to go back a few seconds and replay that passage.

The jump-back time is set as a **JUMPBACK** setting.

- Press the **MENU** button to open the **MENU** screen.
- Use the + or – button to select **PLAY SETTING**, and press the **ENTER/MARK** or **▶▶** button.

PLAY SETTING screen appears.

- Use the + or – button to select **JUMPBACK**, and press the **ENTER/MARK** or **▶▶** button.



- Use the + or – button to set the jump-back time. The setting options include 1 SEC. (1 second) to 10 SEC. (10 seconds) in increments of 1 second, and 20 SEC. (20 seconds), and 30 SEC. (30 seconds) (default: 3 SEC.).
- When finished, press the ϕ / | (HOME) [■] button to return to the Home Screen.

Playback of files recorded using dual recording

When playing back files that have been made using dual recording, press and hold the **1/2 [SOLO]** or **3/4 [SOLO]** buttons to alternate monitoring of the two files created using dual recording.

NOTE

This function (using the **1/2 [SOLO]** and **3/4 [SOLO]** buttons to switch between files) finds the files by the first 11 characters

of file names. If file names are changed, this function will not work.

OVERDUB INPUT MUTE function (during playback)

SEPARATE MODE

Press the **3/4 [SOLO]** button to switch between the input sound and the 3/4 track playback sound.

After overdubbing, you can use this to listen to the recorded file.

MIX MODE

Press the **1/2 [SOLO]** button to mute the input sound.

Solo function

Press and hold the **1/2 [SOLO]** button or **3/4 [SOLO]** button to enable the solo function.

Use for projects that have been recorded in 4-channel mode and in other cases when multiple files are being played back to monitor only one of the files.

You can check the solo status with the track status indications.

7 – Quick Operations

Features of the QUICK button

The **QUICK** button serves for the following purposes.

- While the Home Screen is open and when stopped or paused, opens the Quick menu screen for deletion, division, and level alignment (enhancing the perceived overall sound pressure) of the current playback file. During playback, the Quick menu screen appears only for level alignment.
- While the Home Screen is open during recording standby, the Quick menu screen appears for the setting of level control or the left-right channels for the built-in stereo microphones.
- A pop-up menu to work with a selected file or folder appears if the **BROWSE** screen or the **PLAYLIST** screen is open.

NOTE

The **QUICK** button is disabled if the **MENU** screen, **OTHERS** submenu, **REC SETTING** screen, or a settings screen is open for various settings.

Actions of the **QUICK** button for different screens and states are as follows.

Screen	State	Action
Home	Stop/ Pause	Opens Quick menu for deletion, division, and level alignment
	Playback	Opens Quick menu only for level alignment
	Recording Standby	Opens Quick menu for level control and MIC LR swap
	Recording	—
Playback Control		Opens Quick menu only for level alignment
BROWSE, PLAYLIST		Opens pop-up menu for working with selected file (or folder)
MENU screen, OTHERS submenu, Other settings screens		—
MIXER screen		Turn MS DECODE on/off and select channels 1/2 and 3/4

Quick menu screen

To show the Quick menu screen, press the **QUICK** button while the Home Screen is open. The contents of this screen depend on the state of the unit at the time when the **QUICK** button is pressed.

When stopped with the Home Screen open

Deletion, division, and level alignment of the current playback file can be selected.



DELETE:

The current file can be deleted. (See “Deleting the selected file (Quick Delete)” on page 88.)

DIVIDE:

The current file can be divided.

(See “Dividing the selected file (Divide)” on page 89.)

LEVEL ALIGN:

The perceived overall sound pressure can be increased to enhance listenability. (See “Increasing the perceived overall sound pressure to enhance listenability (Level Alignment)” on page 90.)

MIX DOWN:

This function combines four channels (with a file each for channels 1/2 and channels 3/4) into one 2-channel L/R file.

When using this, you can make effect level, volume level and stereo position settings freely on the MIXER screen. (See “Mixdown” on page 91.)

During playback with the Home Screen open, or while the Playback Control screen is open

Only level alignment can be selected.



During recording standby with the Home Screen open

You can select the settings of level control or left-right channels for the built-in stereo microphones.



Select **LEVEL CTRL**, and press the **ENTER/MARK** button to open the level control setting pop-up window.

7– Quick Operations



In this window, you can choose from the following three level control options.

PEAK REDUCTION:

When the input sound is too large, the input level is decreased automatically to an appropriate level.

AUTO LEVEL:

When the input sound is too small or too large, the input level is increased or decreased, respectively, automatically to an appropriate level.

LIMITER:

This prevents distortion of sound due to sudden excessive input.

For details of the level control function, see “Using the Level Control Function” on page 50.

NOTE

The input level cannot be changed if the level control function is set to **AUTO LEVEL**.

Closing the Quick menu screen

Press the **QUICK** button to close the Quick menu screen.

Deleting the selected file (Quick Delete)

The currently selected file can be deleted without using the **BROWSE** screen.

- 1 To delete a file, select it using the **◀◀** or **▶▶** button.
- 2 Open the Quick menu screen by pressing the **QUICK** button while the Home Screen is open when stopped.



- 3 Use the **+** or **-** button to select **DELETE**.
- 4 Press the **ENTER/MARK** button. A confirmation screen for file deletion appears.



- 5 Press the **ENTER/MARK** button to delete the file, or press the **⏪ / | (HOME) [■]** button to cancel the deletion.

Dividing the selected file (DIVIDE)

A recorded file can be divided into two at a specified position.

- 1 Select a file to be divided using the **◀◀** or **▶▶** button or the **BROWSE** screen.
- 2 While the Home Screen is open when stopped, press the **QUICK** button to show the Quick menu screen.



- 3 Use the **+** or **-** button to select **DIVIDE**, and press the **ENTER/MARK** button.

DIVIDE screen appears.

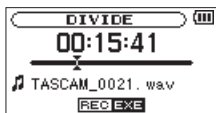

- 4 Use the **+** or **-** button to specify the position for file division, and press the **RECORD** [●] button.

The following pop-up window appears.

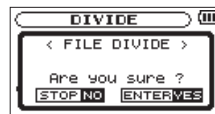

- 5 Press the **ENTER/MARK** button to divide the file. Or press the **⏪** / **| (HOME)** [■] button to return to the **DIVIDE** screen without dividing the file.

NOTE

- When the **DIVIDE** screen is open, you can press the **PLAY** [▶] button and set the divide position while playing the file.
- When the **DIVIDE** screen is open, press the **PLAY** [▶] button to pause/resume playback and press the **◀◀** or **▶▶** button to move to the beginning or the end of the playback file. Adjust the position for file division using the **+** or **-** button. Press and hold the **+** or **-** button to move the position continuously.
- After dividing a file, two new files with "a" and "b" added to the end of the original file name are created.
(4-channel recording file example)

File names before dividing
TASCAM_0003S12.wav
TASCAM_0003S34.wav

File names after dividing
TASCAM_0003aS12.wav (part before division point)

7 – Quick Operations

TASCAM_0003a534.wav (part before division point)
TASCAM_0003b512.wav (part after division point)
TASCAM_0003b534.wav (part after division point)

- MP3 files cannot be divided.
- If the SD card has insufficient open space, division might not be possible.
- Division is not possible if the file name would become more than 200 characters long.
- Division is not possible if a file that already exists has the same name as the name that would be given to a new file created by division.

TIP

Add marks during recording at positions where you want to divide a file. (See “Mark function” on page 65.)

Increasing the perceived overall sound pressure to enhance listenability (Level Alignment)

If the playback sound is very small and indiscernible, the perceived overall sound pressure can be increased to enhance listenability. (Level Alignment)

- 1 While the Home Screen is open when stopped or playing back, press the QUICK button to open the Quick menu screen.

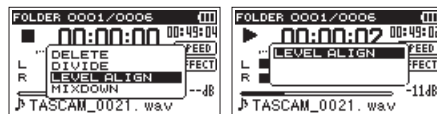

When stopped

During playback

- 2 Use the + or – button to select LEVEL ALIGN and press the ENTER/MARK button.
- 3 A screen to enable/disable the level alignment function appears.



- 4 Use the + or – button to select ON, and press the ENTER/MARK button to enable the level alignment function. Or select OFF and press the ENTER/MARK button to disable the level alignment function.

NOTE

The level alignment function may not be able to achieve sufficient effect depending on the source of the sound

(example: a music file whose sound pressure has been already adjusted).

Mixdown

This function combines four channels (a file each for channels 1/2 and channels 3/4) into one 2-channel L/R file.

Before mixing down, you can make effect level (SEND), stereo position (PAN, or BAL for mono) and volume level (LVL) settings freely on the MIXER screen (see “Mixer” on page 94).

- 1 Use the **◀◀** and **▶▶** buttons or the BROWSE screen to select the file that you want to mix down.
- 2 From the Home Screen when stopped, press the QUICK button to open the Quick Menu screen.



- 3 Use the + and – buttons to select MIXDOWN, and press the ENTER/MARK button to open the MIXDOWN screen.



- 4 Press the ENTER/MARK button to start mixdown.



- 5 After mixdown completes, the playback Home Screen opens with the mixed down file ready to play. (The project name number is the final number before mixdown increased by one.)

In this state, you can press the PLAY [▶] button to start playback of the mixed-down file.

NOTE

If the playback file is mono, the file created will also be mono. When mixing down mono files, set the BAL knob on the MIXER window to L12.

8 – Using the Effects

The DR-40 has built-in effects that can be applied to the input signal during recording and practice. They can also be applied to the output signal during playback.

The **EFFECT** icon appears as light letters on a dark background.

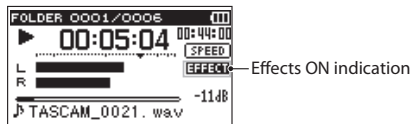

Setting the effect

- 1 Press the **MENU** button to open the **MENU** screen.
- 2 Use the **+** or **-** button to select **OTHERS**, and press the **ENTER/MARK** or **▶▶** button to open the **OTHERS** submenu.
- 3 Use the **+** or **-** button to select **EFFECT**, and press the **ENTER/MARK** or **▶▶** button.

The **EFFECT** screen appears.

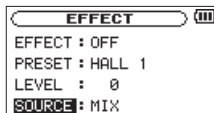

As shown in the above illustration, there are four setting items on the **EFFECT** screen.

Set each item using the **◀◀** or **▶▶** buttons or **+** or **-** buttons.

EFFECT:

Use this to turn the effect on or off.

The default setting is **OFF**.

PRESET:

See the Effects Preset List on page 93 for details about the preset effects.

LEVEL:

Use this to change the output level of the preset effect selected in the **PRESET** item.

Setting range: 0 - 20

SOURCE:

You can choose one of the following as the sound that the effect is applied to (default value: **MIX**).

SOURCE	Explanation
MIX (default value)	Apply the effect to the output of an overdubbed recording or a mixed down recording
INT MIC ST	Apply the effect to signals input through the built-in mics
EXT IN 1/2	Apply the effect to signals input through external mics or equipment

When MIX is selected, you can set the level (SEND) of each signal sent to the effect on the MIXER screen. (See “Mixer” on page 94.)

- 4 Use the + or – button to select the desired item and press the ENTER/MARK button or ►► button to access that item’s settings.
- 5 Use the + or – button to set the desired value.
- 6 Press the ◀◀ button when you are done making the setting to return to item selection status.
- 7 Press the ◻ / [(HOME) [■]] button to return to the Home Screen.

NOTE

When the sampling frequency is set to 96 kHz, or a WAV file with a sampling frequency of 96 kHz is played, the built-in effects do not work.

However, you can still set the built-in effects.

Effects Preset List

Preset name	Effects
HALL 1 (default value)	This is a bright reverb modeled after a large hall-like space.
HALL 2	This is a warm reverb modeled after a large hall-like space.
ROOM	This reverb is modeled on a small indoor space.
STUDIO	This reverb is modeled on a studio-like space.
PLATE 1	This is a bright plate reverb.
PLATE 2	This is a warm plate reverb.

9 – Mixer

This recorder has a mixer function that allows you to set the built-in effect, stereo balance and volume level for each channel.

During mixdown (see “Mixdown” on page 91) and playback, you can make fine adjustments to the recorded sound by using this.

Making mixer settings

- 1 From the Home Screen, press the MIXER button to open the MIXER screen.

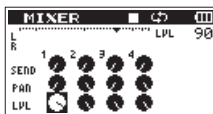

During 4-channel file playback

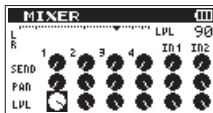

During overdubbing (mix) mode

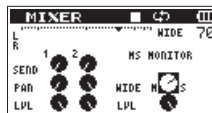

- 2 Use the **◀◀** and **▶▶** buttons and the **+** and **-** buttons to move to and select the item that you want to adjust. Each column is a channel and each row is a setting type.
- 3 Press the **ENTER/MARK** button to open the setting name and value in a pop-up window at the top right.

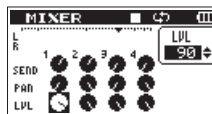

- 4 Use the **+** and **-** buttons to change the setting value.

Item	Setting range	Operation details
SEND	0–100	Adjusts the send level of the selected effect is used on the signal (see 8–Using the Effects” on page 92) (0 (min.)–100 (max.))
PAN/ BAL	L12–C–R12	Adjusts left-right balance (L12 (left)–C (center)–R12 (right))
LEV	0–100	Volume level (0 (min.)–100 (max.))

- 5 Press the **ENTER/MARK** button to return to the previous screen where you can select the next setting that you want to adjust.

NOTE

- The mixer can be used when recording, in recording standby, playing back, paused or stopped.
- Even when the **MIXER** screen is open, you can use the **PLAY** [▶] button to start playback and the **⏏** / **|(HOME)** [■] button to pause playback.
- If **MS DECODE** is set to **ON** on the **REC MODE** screen, the **MIXER** screen **QUICK** menu **MS DECODER** item will show **Using by Input** and will not be usable.

Using the MS decoder

When using MS mics to record, you have two decoding options. You can decode the input sound as you record or you can record as is and decode during playback.

Decoding the input sound as you record

- 1 **Connect MS mics to the external input connectors. Connect the mid mic to the EXT MIC L connector and the side mic to the EXT MIC R connector.**

Decoding cannot be conducted properly if the mid and side mics are connected in reverse.

- 2 **On the REC MODE screen, set the REC MODE to STEREO, DUAL or 4CH, and set the SOURCE to EXT IN 1/2 (in 4CH mode, this item does not appear).**
- 3 **Set MS DECODE to ON.**
- 4 **Start recording to record a decoded MS signal.**

Decoding the playback sound

- 1 **Select a file that was recorded by MS mics with MS DECODE set to OFF.**
- 2 **When the Home Screen is open, press the MIXER button to open the MIXER screen.**
- 3 **Press the QUICK button to select the CH to be used by the MS decoder.**
- 4 **Start playback to decode during playback.**

MS decoder settings

Use the **WIDE** parameter on the **MIXER** screen to adjust the width of the sound.

To decode while recording, open the **MIXER** screen during recording standby.

9 – Mixer

When decoding the input, MS INPUT appears on the MIXER screen. When decoding playback, MS MONITOR appears on the MIXER screen.

Item	Setting range	Operation details
WIDE	0–100	Adjusts the width of the sound

At “0”, mid is 100%. As the number increases, the amount of side signal increases.

NOTE

If MS DECODE is set to ON on the REC MODE screen, it cannot be selected on the MIXER screen (Using by Input appears).

To use the MS decoder during playback, set MS DECODE to OFF on the REC MODE screen.

10 – Tuning a Musical Instrument (Tuner)

TASCAM DR-40 has a built-in tuner. The unit receives a sound from a musical instrument and allows you to tune it accurately on the tuning meter shown in the display.

Using the tuner

Setting the tuner

- 1 Press the **MENU** button to open the **MENU** screen.
- 2 Use the **+** or **-** button to select **OTHERS**, and press the **ENTER/MARK** or **▶▶** button to open the **OTHERS** submenu.
- 3 Use the **+** or **-** button to select **TUNER**, and press the **ENTER/MARK** or **▶▶** button.

TUNER screen appears.

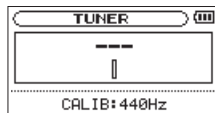

The **TUNER** screen contains the **CALIB** option to set the fundamental frequency of the A. Press the **◀◀** or **▶▶** button to decrease or increase the fundamental frequency.

Setting range: 435Hz - 445Hz (in 1 Hz increments, default: 440Hz)

Tuning a musical instrument

- 1 Open the **TUNER** screen, and sound a note near the unit.
- 2 Tune the instrument so that the target pitch name appears and the center of the tuner lights.

A bar appears on the left or right of the center if the sound is lower or higher than the target pitch. The bar becomes longer as the sound shifts away from the target pitch.



NOTE

The tuner can only be used with the built-in mics.

11 – Connecting with a computer

By connecting this unit with a computer using the USB cable, you can transfer audio files on the SD card in the unit to a computer, as well as transfer audio files on the computer to the SD card in the unit.

This unit can handle audio files of the following formats.

MP3: 32 kbps - 320 kbps, 44.1 kHz/48 kHz

WAV: 44.1 kHz/48 kHz/96 kHz, 16/24 bit

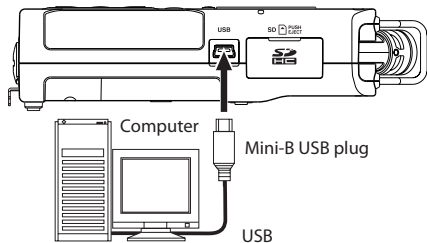

NOTE

- When connected by USB and set to **STORAGE**, the other functions of the recorder are disabled.
- The unit should be connected directly with the computer instead of via a USB hub.
- Instead of using USB to connect the DR-40 and a computer, you can also conduct the same operations by removing the SD card from the DR-40 and connecting it directly to a

computer that has a built-in SD card slot or by using a card reader.

When the unit is connected through USB after being turned on, or when the unit is turned on after being connecting through USB, the **USB SELECT** screen appears to choose between bus power supply or data transmission through USB.



Use the + or – button to select **STORAGE**, and press the **ENTER/MARK** button to connect the unit with the computer for data transmission. The message of **USB connected** appears in the display.



Make sure that the SD card is inserted properly.

NOTE

If the USB cable is connected to the unit when batteries has been installed, the power is supplied from the USB port (USB bus power prioritized).

If an SD card is not properly inserted before making the USB connection, Can't Save Data appears on the screen.

This unit appears on the computer screen as external volume named DR-40.

Transferring files to a computer

- 1 Click the DR-40 drive on the computer screen to show the MUSIC and UTILITY folders.
- 2 Open the MUSIC folder and drag and drop the files that you want to transfer to the computer to destinations of your choice.

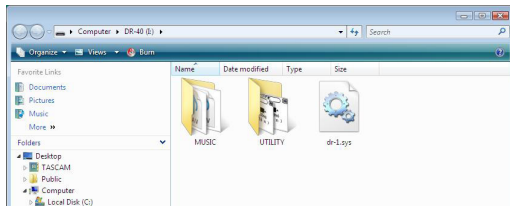

Transferring files from a computer

- 1 Click the DR-40 drive on the computer screen to show the MUSIC and UTILITY folders.

- 2 Drag and drop files on the computer that you want to transfer to the unit to the MUSIC folder.

TIP

- You can manage the MUSIC folder from the computer.
- You can create subfolders in the MUSIC folder up to the second level for use with this unit. The DR-40 cannot recognize subfolders and audio files on the third level or below.
- Since you can set the DR-40 to only play the contents of a specific folder, you can organize files into genres, artists or other categories as you like.
- If you name the subfolders and music files, these names will appear on the screen of this unit.

Disconnecting from a computer

Before disconnecting the USB cable, use the proper procedures for your computer to unmount the DR-40 (as an external drive). The power turns off after disconnecting the USB cable.

See the computer's operation manual for instructions about how to unmount an external drive.

12 – Settings and Information

Viewing File Information

Use the **INFORMATION** Screen to view various types of information about your DR-40.

- 1 Press the **MENU** button to open the **MENU** screen.
- 2 Use the **+ or –** button to select **OTHERS**, and press the **ENTER/MARK** or **▶▶|** button to open the **OTHERS** submenu.
- 3 Use the **+ or –** button to select **INFORMATION**, and press the **ENTER/MARK** or **▶▶|** button.

The **INFORMATION** screen contains the following three pages. Use the **+ or –** button to move through the pages.

File information page (FILE)

Shows information about the currently loaded file.

Card information page (CARD)

Shows the use status of the currently inserted SD card.

System information page (SYSTEM)

Shows the unit's system setting information and firmware version.

File information page

The **FILE** page shows information about the currently selected file.

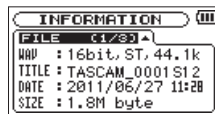

WAV, BWF or MP3

Shows the audio file type.

For WAV or BWF files, bit length, stereo/mono, and sampling frequency (Hz) also appear.

For MP3 files, the bit rate (kbps), CBR (constant bit rate) or VBR (variable bit rate) type, and sampling frequency (Hz) also appear.

TITLE

Shows the file name. If an MP3 file has ID3 tag title information that information appears.

DATE

Date of file creation

SIZE

File size

Card information page

The **CARD** page shows the status of the currently inserted SD card.

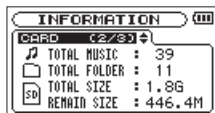

TOTAL MUSIC

Shows the number of playable files contained by the Music Folder.

TOTAL FOLDER

Shows the total number of folders in the Music Folder.

TOTAL SIZE

Shows the total SD card capacity.

REMAIN SIZE/USED SIZE

Shows the amount of unused/used capacity on the SD card.

Press the **◀◀** or **▶▶** button to switch between **REMAIN SIZE** and **USED SIZE**.

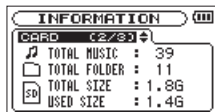

System information page

The **SYSTEM** page shows information about the DR-40's system settings and firmware version.



AUTO OFF

Shows the automatic power OFF setting.

BACKLIGHT

Shows the automatic backlight OFF setting.

BATTERY

Shows the battery type options.

System Ver.

Shows the system firmware version.

System Settings and Formatting

From the **SYSTEM** Screen, you can change various settings to optimize the device for your use environment and other requirements. You can also initialize the unit and format the SD card.

1 Press the MENU button to open the MENU screen.

12 – Settings and Information

- 2 Use the + or – button to select **OTHERS**, and press the **ENTER/MARK** or **▶▶** button to open the **OTHERS** submenu.
- 3 Use the + or – button to select **SYSTEM**, and press the **ENTER/MARK** or **▶▶** button.
SYSTEM screen appears.

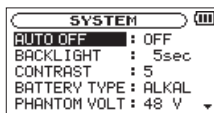

The following settings can be made for the items on the SYSTEM screen.

Use the **◀◀** or **▶▶** button and the + or – button to set each item.

Turning the unit power OFF automatically

Use the **AUTO OFF** item to set the time before the unit power automatically turns OFF after the last activity or use when powered by the battery.

Options: OFF (factory setting—the unit does not automatically turn OFF), 3 min, 5 min, 10 min, 30 min

Setting the backlight

Use **BACKLIGHT** to set the time until the backlight automatically turns OFF after the last operation when powered by the internal battery.

Options: OFF (turned off), 5 sec (factory setting), 10 sec, 15 sec, 30 sec, ALWAYS (always on)

Adjusting the display contrast

Use **CONTRAST** to adjust the display contrast.

Options: 1–20 (factory setting: 5)

Setting the type of AA batteries

Use **BATTERY TYPE** to set the type of the AA batteries that you are using. This setting is used to show the amount of remaining battery charge and determine if the unit has enough power for normal operation.

Values: ALKAL (alkaline batteries, default), Ni-MH (nickel-metal hydride batteries)

Setting the phantom power voltage

Use the **PHANTOM VOLT** item to set the voltage of the phantom power supplied when external mics that require it are connected.

Options: +24V, +48V (factory setting)

Restoring the factory settings

Use the INITIALIZE item to restore the various settings of this unit to their factory settings.

- 1 Use the + or – button to select INITIALIZE, and press the ENTER/MARK or ►► button to highlight Exec.
- 2 Press the ENTER/MARK button again to open a confirmation pop-up window.

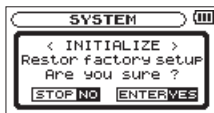

- 3 Press the ENTER/MARK button to initialize the unit. Press ◀/| (HOME) [■] to cancel initialization.

Using QUICK FORMAT

Using QUICK FORMAT erases all music files on the card and automatically creates new MUSIC and UTILITY folders as well as the "dr-1.sys" file that is necessary to use the SD card with the DR-40.

- 1 Use the + or – button to select QUICK FORMAT, and press the ENTER/MARK or ►► button to highlight Exec.
- 2 Press the ENTER/MARK button to open a pop-up confirmation window.

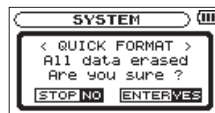

- 3 Press the ENTER/MARK button to execute the quick formatting, or press the ◀/| (HOME) [■] button to cancel formatting.

Using FULL FORMAT

Use the FULL FORMAT item to completely format the SD card. Full formatting checks the memory for errors while formatting, so it takes more time than quick formatting.

Using FULL FORMAT erases all music files on the card and automatically creates new MUSIC and UTILITY folders as well as the "dr-1.sys" file that is necessary to use the SD card with the DR-40.

- 1 Use the + or – button to select FULL FORMAT, and press the ENTER/MARK or ►► button to highlight Exec.
- 2 Press the ENTER/MARK button to open a pop-up confirmation window.

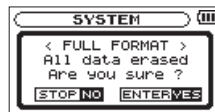

12 – Settings and Information

- 3 Press the **ENTER/MARK** button to execute the full formatting, or press the **⏪/| (HOME) [■]** button to cancel formatting.

CAUTION

When formatting a card, the unit should be operating on AC power supplied through the PS-P515U adapter (sold separately), USB bus power supplied from a computer, or batteries with sufficient remaining power. If the power fails during formatting, the formatting may not occur correctly.

Setting the format of file names

You can select the format of names given to files recorded by this unit.

- 1 Press the **MENU** button to open the **MENU** screen.
- 2 Use the **+ or –** button to select **OTHERS**, and press the **ENTER/MARK** or **▶▶|** button to open the **OTHERS** submenu.
- 3 Use the **+ or –** button to select **FILE NAME**, and press the **ENTER/MARK** or **▶▶|** button.
FILE NAME screen appears.



Use the **◀◀** or **▶▶** button and the **+** or **–** button to set each item.

On this screen you can make the following settings for each item.

File name format

The **TYPE** item can be set to either **WORD** (default setting) or **DATE**.

WORD: When set to **WORD**, a 6-character file name is used as the beginning of each file name.

Example: TASCAM_0001S12.wav

DATE: The date is used as the file name (in **yymmdd** format).

Example: 110101_0000.wav

NOTE

The date is set using the unit's internal clock. (See "Setting the date and time" on page 37.)

Setting the WORD item

To set the WORD item, use the **◀◀** and **▶▶** buttons to move the cursor, and use the **+** or **-** button to select the character.

In addition to the alphabet and numbers, the following characters can be used:

! # \$ % & # () + , - . : ; = @ [] ^ _ ` { } ~

Resetting the number (COUNT)

Select **COUNT INIT**, and press the **ENTER/MARK** button to execute it. The next file created after this will have the number "0001" after the characters set using the WORD item.



13 – Using the REMOTE jack

This unit has a **REMOTE** jack to which you can connect a TASCAM RC-3F footswitch-type remote control or TASCAM RC-10 wired remote control (both sold separately) that can be used to operate the unit.

Footswitch (TASCAM RC-3F)

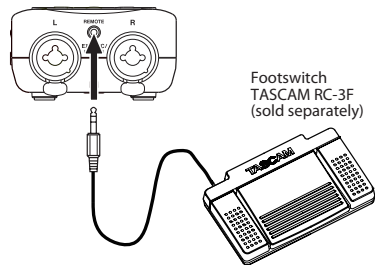

Setting footswitch operation

Use the **REMOTE** setting screen to make footswitch settings.

- 1 Press the **MENU** button to open the **MENU** screen.
- 2 Use the **+ or –** button to select **OTHERS**, and press the **ENTER/MARK** or **▶▶|** button to open the **OTHERS** submenu.

- 3 Use the **+ or –** button to select (**highlight**) **REMOTE** menu item, and press the **ENTER/MARK** or **▶▶|** button to open the **REMOTE** screen.

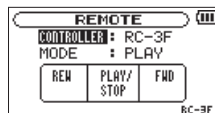

- 4 Use the **+ or –** button to select (**highlight**) **CONTROLLER** menu item, and press the **ENTER/MARK** or **▶▶|** button.
- 5 Use the **+ or –** button to change the **CONTROLLER** item to **RC-3F**. (**Default: RC-3F**).
- 6 Use the **◀◀** and **+ or –** button to select (**highlight**) **MODE** item, and press the **ENTER/MARK** or **▶▶|** button.
- 7 Use the **+ or –** button to change the **MODE** item.
Options: **PLAY** (default), **RECORD1**, **RECORD2**, **MINUTES**
- 8 Press the **⏪ / | (HOME) [■]** button to return to the Home Screen.

Using the footswitch

Press a pedal on the footswitch to operate the unit. The function of each pedal corresponds to the assignment shown on the REMOTE screen.

Mode functions

The functions for each mode are as follows.

MODE	FOOT SW		
	L	C	R
PLAY	REW	PLAY/STOP	FWD
RECORD 1	STOP	REC/PAUSE	INC
RECORD 2	STOP	REC/PAUSE	MARK
MINUTES	FLASH	PLAY/STOP	SPEED CHANGE

Remote control (TASCAM RC-10)

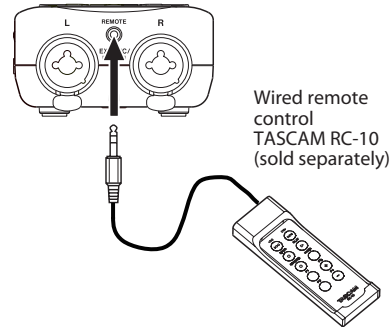

Setting the wired remote control

Make wired remote control settings on the REMOTE screen.

- 1 Press the **MENU** button to open the **MENU** screen.
- 2 Use the **+** and **-** buttons to select the **OTHERS** menu, and press the **ENTER/MARK** or **▶▶|** button to open the **OTHERS** submenu.
- 3 Use the **+** and **-** buttons to select **REMOTE**, and press the **ENTER/MARK** or **▶▶|** button to open the **REMOTE** screen.
- 4 Use the **+** and **-** buttons to select **CONTROLLER** and press the **ENTER/MARK** or **▶▶|** button.

13 – Using the REMOTE jack

- 5 Use the + and – buttons to set **CONTROLLER** to RC-10 (default value: RC-3F).

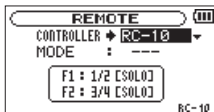

- 6 When setting is complete, press the **HOME** button to return to the Home Screen.

Using the wired remote control

Press the function buttons (**F1** and **F2**) on the wired remote control to use the function assigned on the **REMOTE** screen.

Overview of mode functions

MODES	Function buttons			
	F1	F2	F3	F4
---	1/2 [SOLO]	3/4 [SOLO]	INPUT VOL +	INPUT VOL -

14 – Messages

The following is a list of the popup messages that might appear on the DR-40 under certain conditions. Refer to this list if one of these popup messages appears and you want to check the meaning or determine a proper response.

Message	Meaning and response
File Name ERR	The DIVIDE function would cause the file name to exceed 200 characters. The DIVIDE function adds “a” or “b” to the end of the original file name. Before choosing the DIVIDE function, connect the unit to a computer and edit the file name to less than 198 characters.
Dup File Name	The DIVIDE function would cause the file name to be the same as that of an existing file. The DIVIDE function adds “a” or “b” to the end of the original file name. Before choosing the DIVIDE function, connect the unit to a computer and edit the file name.
File Not Found	The file added to the playlist cannot be found or a file could be damaged. Please check the file in question.
Non-Supported	The audio file is not a supported format. Please see "11 - Connecting with a computer" for file formats that this unit can use.
Battery Empty	The battery is almost out of power. Replace the AA batteries.
I/O Too Short	The IN and OUT points are too close together. Reset the IN and OUT points with at least 1 second between them.
File Not Found PLAYLIST	The file in the Playlist cannot be found. Please confirm that the file is still in the Music Folder.
No PLAYLIST	No files have been added to the Playlist. Add a file to the Playlist or change the play mode to something besides PLAYLIST.
PLAYLIST Full	The playlist is full. You cannot add more than 99 files to the Playlist.
MBR Error Init CARD	The card is not formatted properly or the formatting is broken. Change the card or press the ENTER/MARK button when this message appears to format the card in FAT format. CAUTION: Execution of FAT formatting erases all data currently on the card.
Format Error Format CARD	The FAT formatting of the card is abnormal or broken. This message also appears if you FAT formatted the card using a computer connected by USB and if a new card is inserted in the unit. Always use the DR-40 to conduct FAT formatting of cards to be used with it. Change the card or press the ENTER/MARK button when this message appears to format the card in FAT format. CAUTION: Execution of FAT formatting erases all data currently on the card.

14 – Messages

Message	Meaning and response
File Not Found Make Sys File	The system file is missing. This unit requires a system file for operation. When this message appears, press the ENTER/MARK button to automatically create a system file.
Invalid SysFile Make Sys File	The system file required to operate this unit is invalid. When this message appears, press the ENTER/MARK button to automatically create a system file.
Invalid Card Change Card	Something might be wrong with the card. Change the card.
Write Timeout	Writing to the card timed out. Backup files on the card to your computer, and format the card.
Card Full	The card has no remaining capacity. Erase unnecessary files or move them to your computer to make open space.
Layer too Deep	Folders can be created down to two layers. You cannot create a new folder inside the current folder.
Can't Divide	The position selected for divide is not suitable (too close to the beginning or end of a file).
Max File Size	The file is larger than the designated size or the recording time exceeded 24 hours.
File Full	The total number of folders and files exceeds 5000. Erase unnecessary files or move them to your computer.
Card Error	The card could not be handled properly. Replace the card.
Current File MP3	MP3 files cannot be divided.
File Protected	The file is read only and cannot be erased.
No Card	No SD card is in the unit. Install a recordable SD card.
No PB File	There is no file that can be played back. The file might be damaged.
No MUSIC File	There is no playback file, so DIVIDE and OVERDUB cannot be executed.
Cannot overdub! See REC setting9	You cannot overdub a WAV file with a sampling frequency of 96 kHz in MP3 format. Change the recording format to WAV.
Using by Input	The MS decoder is being used on the input. To use it on monitoring, on the REC MODE screen, set MS DECODE to OFF .
Now DUAL REC	In dual recording mode, change the input level control setting on the REC MODE screen.
Now OVERDUB	The MS decoder cannot be used in overdubbing mode.
Virtual File!	Virtual files cannot be played back or added to playlists. To play the file back use FILE SWAP .

Message	Meaning and response
Can't File Swap	FILE SWAP cannot be used with projects that have only one file.
Now Auto Rec	When auto-recording is enabled, the SelfTimer does not function. Set AUTO REC OFF on the REC SETTING screen.
Not Continued	
File Error	
Can't Save Data	
Player Error	
Device Error	
Writing Failed	
Sys Rom Err	
Remote Cmd	
Remote Rx	
System Err 50	If any of these errors occurs, turn the unit's power off and restart it. If the power cannot be turned off, remove the batteries, disconnect the AC adaptor (TASCAM PS-P515U), and/or disconnect the USB cable for bus power supply. If the error message continues to appear frequently, please contact a TASCAM Customer Support.
System Error 1	
System Error 2	
System Error 3	
System Error 4	
System Error 5	
System Error 6	
System Error 7	
System Error 8	
System Error 9	

15 – Troubleshooting

If you are having trouble with the operation of this unit, please try the following before seeking repair. If these measures do not solve the problem, please contact the store where you bought the unit, an authorized distributor or a TASCAM Customer Support.

■ Power will not turn ON.

- Confirm that the batteries are not dead.
- Confirm that the batteries are installed with the correct +/- orientation.
- Confirm that the AC adapter (TASCAM PS-P515U, sold separately) is firmly connected to both the socket and the unit.
- Confirm that the USB cable (if used for USB bus power supply) is firmly connected.
- Confirm that the USB cable (if used for USB bus power supply) is not connected via a USB hub.

■ The unit does not function.

- Confirm that the **HOLD** switch is not set in the direction of the arrow.
- Is the unit connected to a PC with the USB cable? (Is **USB connected** shown on the display?)

■ The SD card is not recognized.

- Confirm that the SD card is inserted completely.

■ Playback does not work.

- If you are trying to play a WAV file, confirm that the sampling frequency is supported by this unit.
- If you are trying to play an MP3 file, confirm that the bit rate is supported by this unit.

■ The speakers do not work.

- Are headphones connected?
- Is **SPEAKER** set to **OFF**?
- Check the connections with the monitoring system.
- Is the volume of the monitoring system minimized?
- Is the **OUTPUT LEVEL** setting of the unit minimized?

■ Recording does not work.

- If you are using an external device, check the connection again.
- Check the input settings again.
- Confirm that the input level is not too low.
- Confirm that the SD card is not full.
- Confirm that the number of files has not reached the maximum that the unit can handle.

■ **The input level is low.**

- Confirm that the input level setting is not too low.
- Confirm that the output level of a connected external device is not too low.

■ **The sound I am trying to record sounds distorted.**

- Confirm that the input level setting for recording (INPUT LEVEL) is not too high.
- Do the built-in effects work?

■ **The playback sounds unnatural.**

- Confirm that the playback speed is not being adjusted.
- Confirm the setting of the playback equalizer.
- Confirm that the level alignment function is not enabled.
- Do the built-in effects work?

■ **I cannot erase a file.**

- Confirm that you are not trying to erase a file that has been copied from a computer after being write-protected.

■ **This unit's files do not appear on the computer.**

- Confirm that the unit is connected to the computer using its USB port.
- Confirm that USB hubs are not used.
- Confirm that the unit is not recording or in recording standby mode.

16 – Specifications

Ratings

Recording media

SD card (64 MB - 2 GB)

SDHC card (4 GB - 32 GB)

Recording/playback format

BWF: 44.1/48/96 kHz, 16/24-bit

WAV: 44.1/48/96 kHz, 16/24-bit

MP3: 44.1/48 kHz, 32/64/96/128/192/256/320 kbps

Number of channels

4 channels (stereo x 2)

Input/output ratings

Analog audio input/output ratings

EXT MIC/LINE IN jacks (phantom power supported)

Connector:

XLR-3-31 (1: GND, 2: HOT, 3: COLD)

6.3 mm (1/4") TRS Standard jack (Tip: HOT, Ring: COLD,
Sleeve: GND)

When **EXT IN** switch set to **MIC, MIC + PHANTOM**

Input impedance: 2.2 k Ω

Nominal input level: -19 dBV

Maximum input level: -3 dBV

When **EXT IN** switch set to **LINE**

Input impedance: 10 k Ω or more

Nominal input level: +4 dBu

Maximum input level: +20 dBu

/LINE OUT jack

Connector: 1/8" (3.5 mm) stereo mini

Output impedance: 12 Ω

Nominal output level: -14 dBV (10 k Ω load)

Maximum output level: +2 dBV (10 k Ω load)

Maximum output: 20 mW + 20 mW (when connected to
headphones, 32 Ω load)

Built-in speaker

0.3 W (monaural)

Control input/output ratings

USB jack

Connector: Mini-B type

Format: USB 2.0 HIGH SPEED mass storage class

REMOTE jack

Connector: 2.5 mm TRS jack

Audio performance

Frequency response

20 - 20 kHz +1/-3 dB

(EXT IN to LINE OUT, Fs 44.1 kHz, JEITA)

20 -22 kHz +1/-3 dB

(EXT IN to LINE OUT, Fs 48 kHz, JEITA)

20 - 40 kHz +1/-3 dB

(EXT IN to LINE OUT, Fs 96 kHz, JEITA)

Total harmonic distortion

0.05% or lower (EXT IN to LINE OUT, Fs 44.1/48/96 kHz, JEITA)

S/N ratio

92 dB or higher (EXT IN to LINE OUT, Fs 44.1/48/96kHz, JEITA)

Note) JEITA: Conforming to JEITA CP-2150

Computer compatibility

Windows

Pentium 300 MHz or faster

128 MB or more memory

USB port (USB 2.0 recommended)

Macintosh

Power PC, iMac, G3, G4 266 MHz or faster

64 MB or more memory

USB port (USB 2.0 recommended)

Recommended USB host controller

Intel chipset

Supported OS

Windows XP, Windows Vista, Windows 7

Macintosh Mac OS X 10.2 or later

16 – Specifications

Other specifications

Power

Three AA batteries (Alkaline or Ni-MH)

USB bus power supplied from a computer

AC adaptor (TASCAM PS-P515U, sold separately)

Power consumption

1.7 W (maximum)

Battery operation time (continuous operation)

Alkaline type battery (EVOLTA)

Format	Continuous operation time	Note
Recording, 2 ch WAV, 96 kHz, 24 bit	About 16 hours	Built-in stereo microphone
Recording, 2 ch WAV, 44.1 kHz, 16 bit	About 20.5 hours	Built-in stereo microphone
Recording, 2 ch MP3, 44.1 kHz, 128 kbps	About 18 hours	Built-in stereo microphone
Recording, 4 ch WAV, 96 kHz, 24 bit	About 8.5 hours	Built-in stereo microphone + line
Recording, 4 ch WAV, 44.1 kHz, 16 bit	About 9 hours	Built-in stereo microphone + line
Recording, 4 ch MP3, 44.1 kHz, 128 kbps	About 9.5 hours	Built-in stereo microphone + line
Playback, 2 ch WAV, 96 kHz, 24 bit	About 16 hours	Headphones

Format	Continuous operation time	Note
Playback, 2 ch WAV, 44.1 kHz, 16 bit	About 21.5 hours	Headphones
Playback, 2 ch MP3, 44.1 kHz, 128 kbps	About 17.5 hours	Headphones
Playback, 4 ch WAV, 96 kHz, 24 bit	About 15.5 hours	Headphones
Playback, 4 ch WAV, 44.1 kHz, 16 bit	About 17.5 hours	Headphones
Playback, 4ch MP3, 44.1 kHz, 128 kbps	About 16.5 hours	Headphones

Ni-MH type battery (eneloop)

Format	Continuous operation time	Note
Recording, 2 ch WAV, 96 kHz, 24 bit	About 12 hours	Built-in stereo microphone
Recording, 2 ch WAV, 44.1 kHz, 16 bit	About 17 hours	Built-in stereo microphone
Recording, 2 ch MP3, 44.1 kHz, 128 kbps	About 15 hours	Built-in stereo microphone
Recording, 4 ch WAV, 96 kHz, 24 bit	About 8 hours	Built-in stereo microphone + line
Recording, 4 ch WAV, 44.1 kHz, 16 bit	About 8.5 hours	Built-in stereo microphone + line
Recording, 4 ch MP3, 44.1 kHz, 128 kbps	About 8.5 hours	Built-in stereo microphone + line
Playback, 2 ch WAV, 96 kHz, 24 bit	About 14 hours	Headphones

Format	Continuous operation time	Note
Playback, 2 ch WAV, 44.1 kHz, 16 bit	About 17.5 hours	Headphones
Playback, 2 ch MP3, 44.1 kHz, 128 kbps	About 14.5 hours	Headphones
Playback, 4 ch WAV, 96 kHz, 24 bit	About 13 hours	Headphones
Playback, 4 ch WAV, 44.1 kHz, 16 bit	About 15 hours	Headphones
Playback, 4ch MP3, 44.1 kHz, 128 kbps	About 15 hours	Headphones

Dimensions (W x H x D)

70 x 155 x 35 mm/2.756 x 6.102 x 1.378 inches

(when the microphone pair is close)

90 x 155 x 35 mm/3.543 x 6.102 x 1.378 inches

(when the microphone pair is open)

Weight

213 g/7.51 (oz) (not including batteries)

Operating temperature range

0 - 40°C (32°F - 104°F)

Dimensional drawings

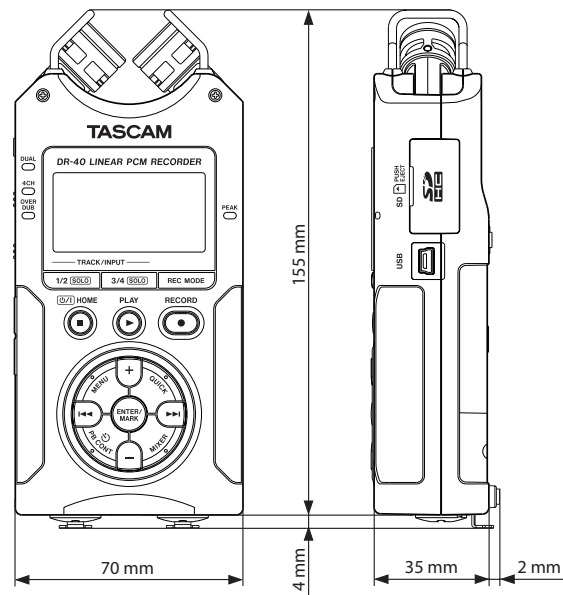

16 – Specifications

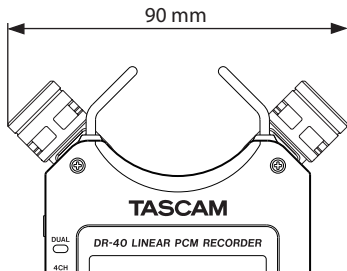

Dimension of the microphone opened

- Illustrations and other depictions may differ in part from the actual product.
- Specifications and external appearance may be changed without notification to improve the product.

TASCAM

DR-40

User registration

Customers in the USA, please visit the TASCAM website (<http://tascam.com/>) to register as a user online.

TEAC CORPORATION

Phone: +81-42-356-9143
1-47 Ochiai, Tama-shi, Tokyo 206-8530 Japan

<http://tascam.jp/>

TEAC AMERICA, INC.

Phone: +1-323-726-0303
7733 Telegraph Road, Montebello, California 90640 USA

<http://tascam.com/>

TEAC CANADA LTD.

Phone: +1905-890-8008 Facsimile: +1905-890-9888
5939 Wallace Street, Mississauga, Ontario L4Z 1Z8, Canada

<http://tascam.com/>

TEAC MEXICO, S.A. de C.V.

Phone: +52-55-5010-6000
Río Churubusco 364, Colonia Del Carmen, Delegación Coyoacán, CP 04100, México DF, México

<http://www.teacmexico.net/>

TEAC UK LIMITED

Phone: +44-8451-302511
Suites 19 & 20, Building 6, Croxley Green Business Park, Hatters Lane, Watford, Hertfordshire. WD18 8TE, U.K.

<http://www.tascam.co.uk/>

TEAC EUROPE GmbH

Phone: +49-611-71580
Bahnstrasse 12, 65205 Wiesbaden-Erbenheim, Germany

<http://tascam.de/>