

INSTALLER'S GUIDE

SENS-IN-1D 18-HD60D29-4

Customer Property - Contains wiring, service, and operation information. Please retain.

Library	Service Literature
Product Section	Unitary
Product	Unitary Accessory
Model	T'stat, Panels, Timers, Relays
Literature Type	Installer's Guide
Sequence	1D
Date	January 2001
File No.	SV-UN-ACC-SENS-IN-1D 1/01
Supersedes	SENS-IN-1C

Model: BAYSENS019B ASYSTAT666B	Used with: 2-25 T. Packaged Heat/Cool Units 2-20 T. Packaged Heat Pump Units 27.5-50 T. Packaged Heat/Cool Units 20-130 T. Packaged Rooftop Units 20-80 T. Commercial Self-Contained Units
---	--

PROGRAMMABLE ZONE SENSOR FOR CONSTANT VOLUME (CV) UNITS AND HEAT PUMP (HP) UNITS

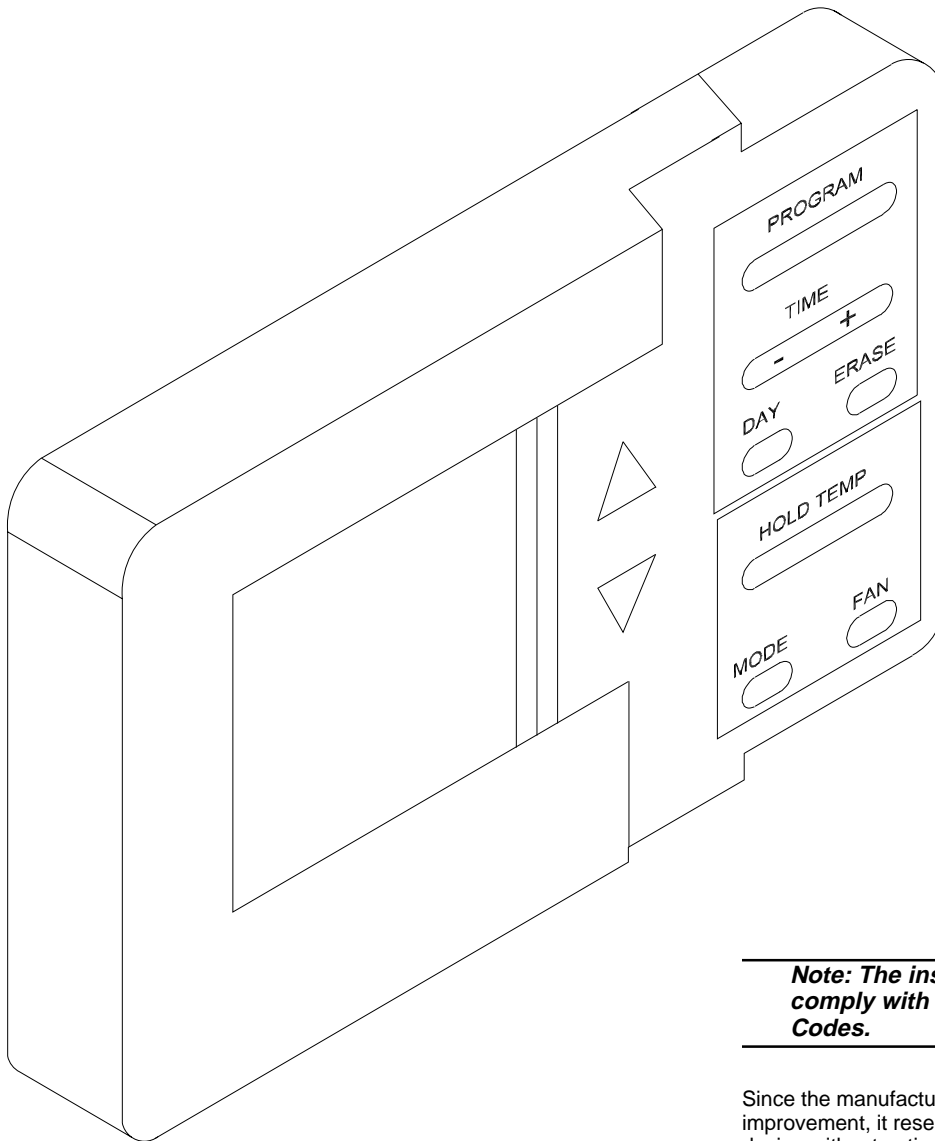

Note: The installation of this equipment must comply with all National, State, and Local Codes.

Since the manufacturer has a policy of continuous product improvement, it reserves the right to change specifications and design without notice.

About the Manual

Literature Change History

SENS-IN-1A September 1997

Original Installation manual for mounting, wiring and programming the Programmable Zone Sensor.

SENS-IN-1B March 1998

Updated Programmable Zone Sensor Installation manual due to zone sensor redesign.

SENS-IN-1C February 2000

Updated Programmable Zone Sensor Installation manual due to internal Sensor changes and to clarify programming instructions.

Overview of Manual

Note: One copy of this document ships inside each Programmable Zone Sensor kit and is customer property. The unit's maintenance personnel must retain it.

This booklet describes step-by-step instructions for installing and programming the Programmable Zone Sensor.

By carefully reviewing the information within this manual and following the instructions, the risk of improper operation and/or component damage will be minimized.

Should equipment failure occur, contact a qualified service organization with qualified, experienced HVAC technicians to properly diagnose and repair this equipment.

Note: The procedures discussed in this manual should only be performed by qualified, experienced HVAC technicians.

General Information

Kit Inspection

Upon receipt of the kit, immediately note;

- [] Any visible damage to the exterior shipping package. Record any damage on the shipping documents.

Specify the type and extent of the damage on the "bill of lading" before signing.

- [] Unpack the contents and carefully inspect it for obvious damage due to shipment.

- [] If concealed damage has occurred, notify the carrier's terminal of the damage immediately by phone and by mail. Concealed damage must be reported within 15 days.

- [] Do not remove damaged material from the receiving location. Take photos of the damage, if possible. The owner must provide reasonable evidence that the damage did not occur after delivery.

- [] Check for material shortages. Within the package you should find;
 - 1 - Sensor Module,
 - 1 - Package of mounting hardware, and;
 - 1 - Installation and operation manual.

Contact the Parts Center nearest your area should there be any damaged or missing components.

Remote Panel w/ NSB - BAYSENS019B

This 7 day programmable sensor features 2,3 or 4 periods for Occupied or Unoccupied programming per day. If the power is interrupted, the program is retained in permanent memory. If power is off for an extended period of time, only the clock and day may have to be reset.

The Zone Sensor allows selection of four system modes (Heat, Cool, Auto, and Off), two fan modes (On and Auto). It has dual temperature selection with programmable start time capability.

The occupied cooling set point ranges between 45 and 98 degrees Fahrenheit. The heating set point ranges between 43 and 96 degrees Fahrenheit.

A liquid crystal display (LCD) displays zone temperature, temperature set points, day of the week, time, and operational mode symbols.

The Option Menu is used to enable or disable applicable functions, i.e.; Morning Warm-up, Economizer minimum position override during unoccupied status, Fahrenheit or Centigrade, Supply air tempering, Remote zone temperature sensor, 12/24 hour time display, Smart fan, and Computed recovery.

During an occupied period, an auxiliary relay rated for 1.25 amps @ 30 volts AC with one set of single pole double throw contacts is activated.

General Information

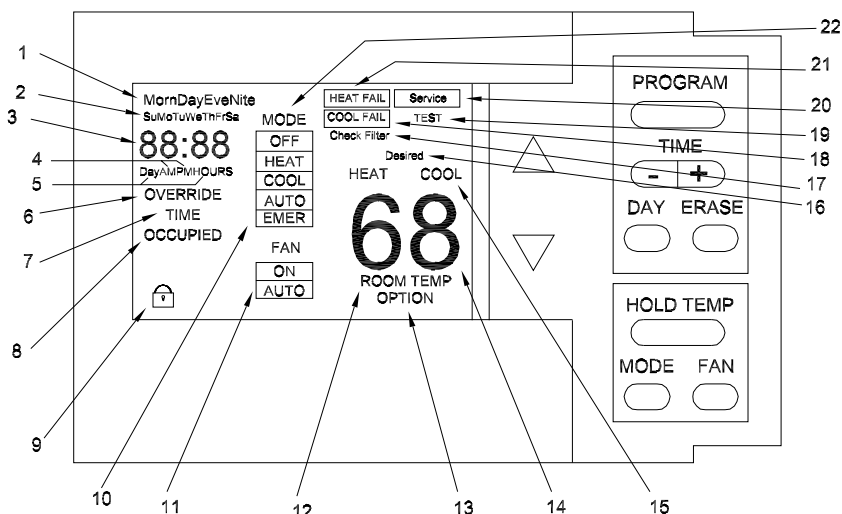

Icon Description

- 1 - The four periods of the day used during programming.
- 2 - The seven days of the week used during programming and in the Normal Run State to indicate the current day.
- 3 - Four digits used to display the time of day in the Normal Run State. Also used in the Programming Menu, Temporary Override Menu, and the Options Menu. The Colon (:) blinks in the Normal Run State to indicate communication to the UCP is functioning.
- 4 - AM and PM used to display the time of day (Morning/Evening) in the Normal Run State when using the 12 hour time option.
- 5 - Days and Hours are used in the Temporary Override Menu to program the override time period.
- 6 - Displayed and Blinks during Temporary Override Operator.
- 7 - Displayed in the Temporary Override Programming Menu.
- 8 - Programmable in the Programming Menu and is displayed in the Normal Run State to indicate the current Zone Status.
- 9 - When displayed, indicates the keypad is locked out.
- 10 - Emergency Heat selection available when used with a heatpump application and programmed in the Options Menu.
- 11 - Displays the FAN operation Mode.
- 12 - Displayed in the Normal Run State when the Zone Temperature is programmed to be displayed in the Options Menu.
- 13 - Displayed only in the Options Menu.
- 14 - Two digits used to display the Zone Temperature when programmed in the Options Menu.
- 15 - Indicates UCP operating status in the Normal Run State and is used in the Programming Menu and Temporary Override Menu to set the desired operating setpoints.
- 16 - Displayed in the Programming Menu and Temporary Override Menu to indicate the desired operating setpoints.
- 17 - Displayed and Blinks when the programmed Check Filter time has elapsed.
- 18 - Displayed and Blinks when a Cooling Failure has occurred.
- 19 - Displayed during the UCP self-test mode.
- 20 - Displayed and Blinks during Service Status and if Fan Failure occurs.
- 21 - Displayed and Blinks when a Heating Failure has occurred.
- 22 - Displays the System operation Mode.

Installation

Sensor Mounting

1. Mounting location.

- Choose a location on an interior wall near the return air grille, approximately five feet above floor level, where air circulates freely and is of average temperature for the zone.
- Avoid areas such as:
 - behind doors;
 - on outside walls, or any walls with unconditioned areas behind the sensor;
 - in direct sunlight, or any source of radiant heat that could affect the temperature measurements;
 - in line with the discharge air from the unit being controlled.

2. Mounting the sub base.

The mounting hardware is contained in a plastic bag that includes;

- 3 - plastic wall anchors
- 3 - mounting screws
- 1 - terminal strip (TB), set aside for later use.

- Remove the sensor from its sub base.
Hold the Sensor with one hand and firmly grasp the sub base with the other hand. Gently pull the bottom, away and upward. Refer to Figure 1.

After disassembling the sensor, protect the internal surface from contacting objects or substances that could cause damage.

- To determine the appropriate number of wires required, refer to Figure 3.
- Route the wires from the wall through the wire access hole in the sub base. Refer to Figure 2.
- Mount the sub base directly on the wall or on a 2X4 handy box (Handy Box must be installed Horizontally).

To mount the sub base directly on the wall, hold it in place and mark the three holes. Drill three 3/16 inch (4.8 mm) holes. Gently tap the plastic anchors into the holes until they are flush with the wall. Level the sub base and firmly tighten the mounting screws. **OVER TIGHTENING THE SCREWS could crack the sub base.**

To mount the sub base on a 2X4 handy box mounted horizontally, Level the sub base and firmly tighten the mounting screws. **OVER TIGHTENING THE SCREWS could crack the sub base.**

If the handy box is installed vertically, a mounting plate and adapter kit (#BAYMTPL003B) is required. Follow the instructions that are enclosed with the mounting kit.

- Seal the hole in the wall behind the sub base.

Figure 1
Removing the Sensor from the Sub Base

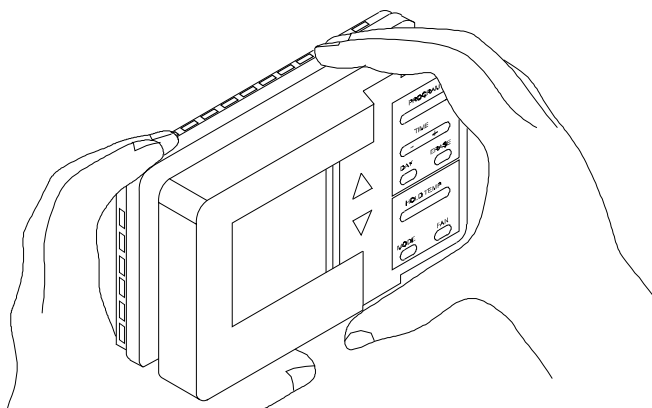
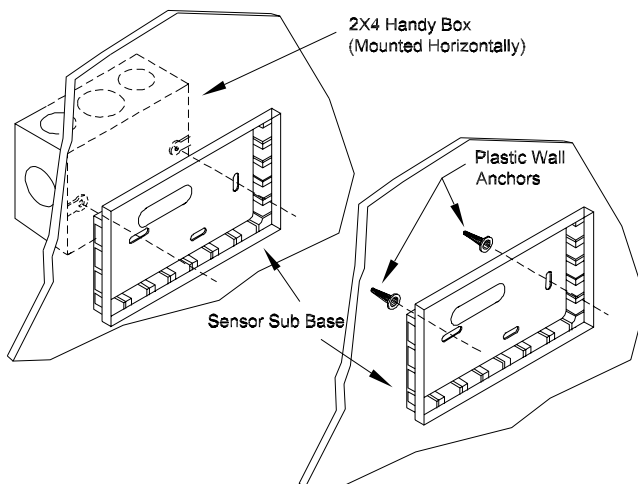

Figure 2
Mounting the Sub Base



Conductors and Terminal Identification

Operating Power (2 Wires)

24 VAC power supplied from the Unit Control provides the operating power for the ZSM. The power supply should be connected to the terminals 11 & 14 on the ZSM.

Remote Zone Temperature Sensor (2 Wires Optional)

The ZSM supports the use of a remote zone temperature sensor. The remote sensor should be a thermistor type sensor (Baysens017). When connecting the remote sensor, use terminals S1 and S2 on the ZSM. Connect the Shield wire (drain wire) from the shielded cable to terminal 11 on the ZSM.

Note: When using a remote sensor, Option # 11 in the OPTION MENU must be set to "1".

Communication (1 Wire)

Data communication between the UCM and the ZSM is accomplished over a serial link connected at terminal 12 on the ZSM.

Installation

UCM Status Inputs (4 Wires Optional)

The ZSM can be wired to receive four (4) operating status signals from the UCM (HEAT, COOL, SYSTEM "ON", SERVICE). Four (4) wires from the UCM should be connected to the appropriate terminals (7, 8, 9 & 10) on the ZSM.

Auxiliary Relay (3 Wires Optional)

The auxiliary relay located on the ZSM is energized during OCCUPIED periods. The auxiliary relay is form C, rated for 1.25 Amps at 30 VAC. Figure 3 illustrates the terminal configuration.

Note: Guidelines for wire sizes and lengths are shown in Table 1. The total resistance of these low voltage wires must not exceed 2.5 ohms per conductor. Any resistance greater than 2.5 ohms may cause the control to malfunction due to excessive voltage drop.

Note: Do not run low-voltage control wiring in same conduit with high-voltage power wiring.

Table 1
Zone Sensor Maximum Lengths and Wire Size

Distance from Unit to Control	Recommended Wire Size
000 - 150 feet	22 gauge
151 - 240 feet	20 gauge
241 - 385 feet	18 gauge
386 - 610 feet	16 gauge
611 - 970 feet	14 gauge

Wiring The Sub Base



HAZARDOUS VOLTAGE!

DISCONNECT ALL ELECTRIC POWER INCLUDING REMOTE DISCONNECTS BEFORE SERVICING.

Failure to disconnect power before servicing can cause severe personal injury or death.

Connecting the wires

1. Strip approximately ¼ inch of insulation from each wire and connect the wiring to the appropriate terminals at the unit control panel.
2. Remove the Terminal Block from the hardware package and connect the wiring to the appropriate terminals at the Zone Sensor sub base. In general, zone sensor connections use the convention of connecting Zone Sensor terminals to like numbered Unit terminals (1 to 1, 2 to 2, etc.). Refer to Figure 3.
3. Firmly tighten each screw terminal.
4. Attach the terminal block to the Sensor PC Board.
5. Fit the wires as close to the sub base as possible. Be sure to push the excess wire into the wall and plug the hole with nonflammable insulation to prevent drafts from affecting the sensor.

Note: Do Not Coil Excess Wire Inside Sub Base! Push All Excess Wire Inside Handy Box Or Inside Wall Cavity.

6. Replace cover. Place the zone sensor on the sub base by hooking the top two tabs on the Zone Sensor Module to the slotted tabs on top of the sub base. Swing the ZSM straight down onto the sub base until you hear the plastic locking mechanism snap securely into place.

Note: If the wire bundle is large, it may cause the terminal strip to become disconnected. Secure the wires to the sub base using a small wire tie.

Installation

Figure 3
Zone Sensor Connection Diagram

Connect the control wire to the appropriate terminal board for the applicable unit. The Zone Sensor is designed for single unit control only.

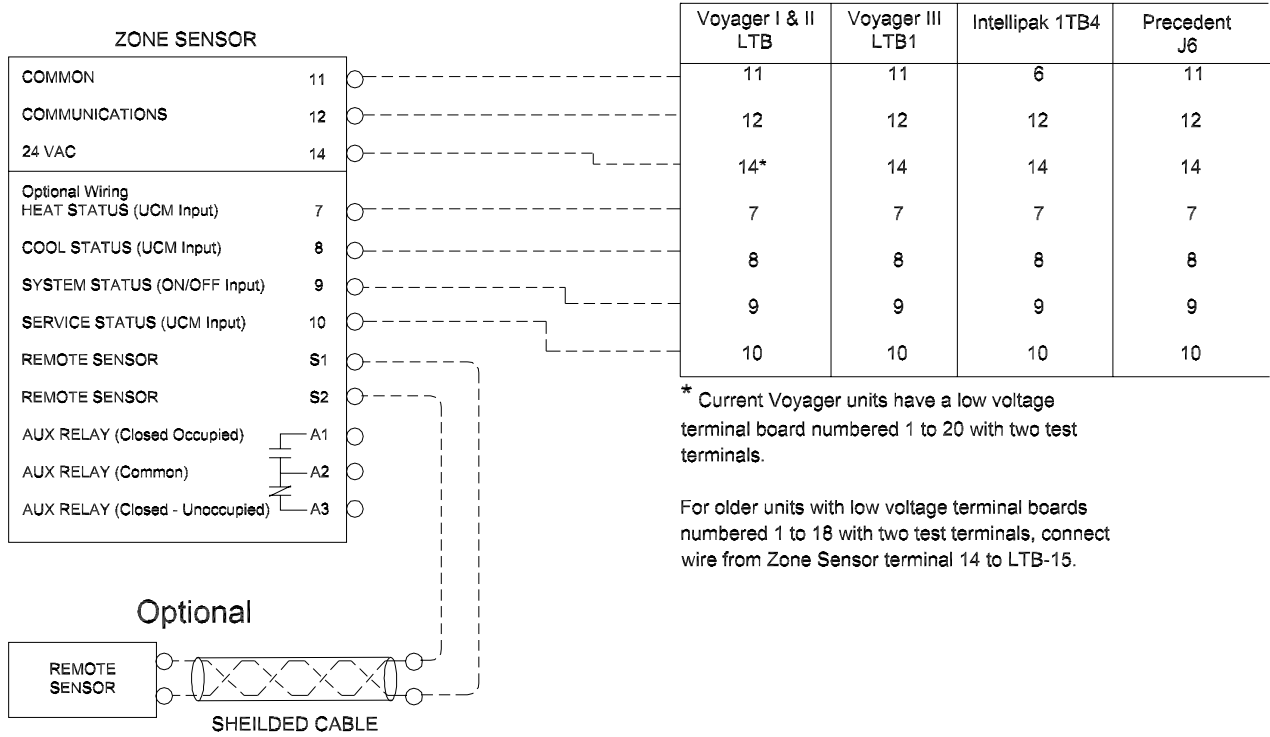

Programming And Operation

Initial Power-Up

Before applying power to the unit, verify that all wiring is correct.

When the power to the unit has been turned "On", the ZSM will be in the Normal Run State and will begin operating using the factory default settings. The correct day and time settings will need to be verified or set. Refer to the Normal Run State screen.

To set the time, simply press the ("+") or ("-") side of the KEY marked TIME. Press the positive ("+") side to advance the time in one minute intervals. Press the negative ("-") side to decrease the time in one minute intervals. Press and hold either side of the KEY to make rapid changes.

When the correct time is reached, release the TIME KEY and the time will be set.

To set the day, simply press the DAY KEY until the correct day is displayed.

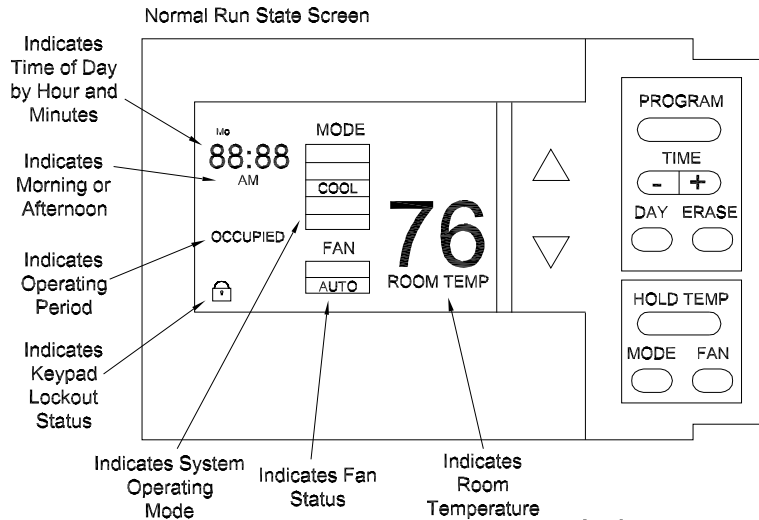

Key Press	Action
PROGRAM	Enter Program Screen
Time +	Scrolls Clock Forward, Scrolls Rapidly If Held Down
Time -	Scrolls Clock Backwards, Scrolls Rapidly If Held Down
Day	Advances Current Day
Hold Temp	Enter Temporary Override Menu
Mode	Advances one position for MODE selection
Fan (CV/HP only)	Toggles Fan Operation Setting or Enters Temporary Override Menu if Option 10 is set to 1
UP Arrow	Switches to Temorary Override and Increases Temp Set Point, Scrolls Rapidly If Held Down
Down Arrow	Switches to Temorary Override and Decreases Temp Set Point, Scrolls Rapidly If Held Down
Erase	Turns off Check Filter Icon, Turns off BEEP until the next day when a HEAT FAIL or COOL FAIL Icon is Displayed
Time + and - simultaneously for 4 seconds	Toggles Keypad Lockout if Option 14 is set to 1
PROGRAM and MODE simultaneously for 4 seconds	Enter Option Menu Screen

Programming And Operation

Option Menu

The Option Menu is used to set all programmable options built into the ZSM. All options are retained in permanent memory.

To display the Option Menu Screen, simultaneously press and hold the MODE KEY and the PROGRAM KEY for 4 seconds.

When the Option Menu Screen is displayed, only the UP and DOWN arrows and the TIME (“+”) and (“-“) KEY are active. Pressing the UP or DOWN arrow advances to the next available option in the menu. Pressing the TIME (“+”) and (“-“) KEY changes the option value associated with each option number.

Refer to the Option Menu Screen illustration and the ZSM options and option values table with a description of each option. Refer to this table while viewing or programming the sensor.

Note: Changing option 9 or 10 will erase the current program setting.

Once the option values have been reviewed or reset, simultaneously press and hold the MODE KEY and the PROGRAM KEY for 4 seconds to return to the Normal Run State. If no KEY is pressed, the ZSM will return to the Normal Run State after 1 minute has elapsed.

Option Menu Screen

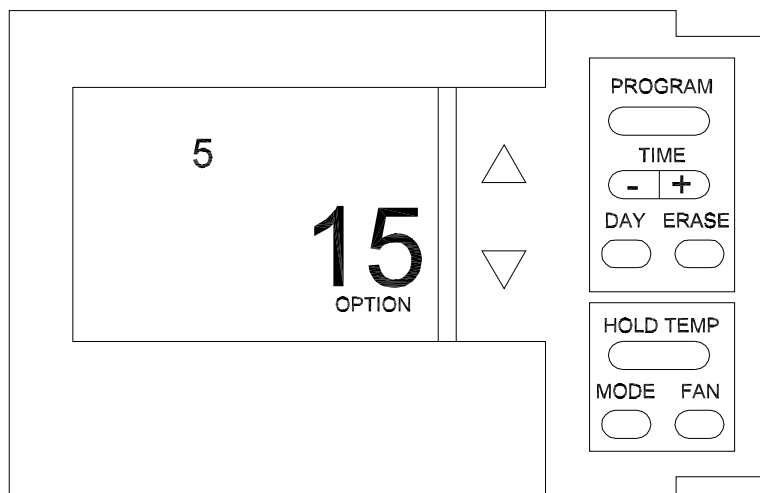

Key Press

Action

PROGRAM and MODE simultaneously for 4 seconds	Enter Option Menu Screen
Time +	Advances Option Value, Scrolls Rapidly If Held Down
Time -	Previous Option Value, Scrolls Rapidly If Held Down
UP Arrow	Advances Option Number, Scrolls Rapidly If Held Down
Down Arrow	Previous Option Number, Scrolls Rapidly If Held Down
PROGRAM and MODE simultaneously for 4 seconds	Exit Option Menu Screen, Returns to Normal Run State
60 seconds without pressing any key	Exit Option Menu Screen, Returns to Normal Run State

Programming And Operation

Option	Function	Option Value	Default	Description
1	Morning warm-up	0 = Disabled 1 = Enabled	0	When enabled, Heat is turned on if the Zone temperature is 2 degrees below the heat set point temperature when the program switches from unoccupied to occupied. The heat will terminate after 60 minutes regardless if the set point has been reached.
2	Economizer minimum position override	0 = Disabled 1 = Enabled	1	When enabled, the minimum position of the economizer damper is overridden during the unoccupied period.
3	Temperature Scale	0 = Fahrenheit 1 = Centigrade	0	Displays the temperature in the selected format.
4	Supply Air Tempering	0 = Disabled 1 = Enabled	0	When enabled, sends the tempering signal to the UCP.
5	Time Clock	0 = 12 hour 1 = 24 hour	0	Sets Clock to 12 hour format with AM and PM or 24 hour military time.
6	Smart Fan	0 = Disabled 1 = Enabled	1	When enabled, the supply fan operates in the AUTO mode during unoccupied periods regardless of FAN setting.
7	Intelligent Temperature Recovery	0 = Disabled 1 = Enabled	0	When enabled, offsets the set point temperature and starts the system before the scheduled occupied period to efficiently reach the occupied temperature set point. The time is calculated based on a recovery rate of 6 degrees per hour. If option 19 is set for HP, this option is disabled during EMERGENCY heat operation.
8	Programmable Days/Week	0 = 7 days (M, T, W, T, F, S, S) 1 = 3 days (M-F, S, S) 2 = 2 days (M-F, S-S) 3 = 1 day (Sun-Sat)	0	0 allows all 7 days to be individually programmed. 1 allows Mon - Fri, Sat & Sun to be programmed separately. 2 allows Mon - Fri and Sat - Sun to be programmed the same. 3 uses the same program for each day of the week.
9	Programmable Periods/Day	2, 3, 4	4	If 2 is selected, only Day and Nite periods can be programmed. If 3 is selected, Morn, Day, and Nite can be programmed. If 4 is selected, Morn, Day, Eve, and Nite can be programmed.
10	Programmable Fan Operation	0 = Disallowed 1 = Allowed	0	If allowed, Supply Fan operation can be programmed for On or Auto operation for each programmed period.
11	Remote Sensor Installed	0 = No 1 = Yes	0	Determines which source will supply the Room Temperature input for display.
12	Check Filter Interval	0 = Disabled 3000 to 50 in 50 hour increments	350	Adjustable in 50 hour increments. The CHECK FILTER icon will flash when the accumulated run time is greater than the interval setting.
13	Display Zone Temperature	0 = No 1 = Yes	1	If ZSM is in a Normal Run State or in Temporary Override, the zone temperature will be displayed.
14	Keypad Lockout Enabled	0 = Disabled 1 = Enabled	1	When Enabled, Keypad can be locked out.
15	Default Temporary Override Time	1, 2, 3, 4, 5	3	Sets the default override time in hours.
16	Buzzer Options	0 = Key Press Only 1 = Key Press and Check Filter 2 = Key Press, Check Filter, and System Failure	1	Buzzer will sound for a 1/2 sec for every minute if option is set for 1 or 2.
17	Zone Temperature Calibration	Zone Temperature Displayed	0 offset	This allows for field calibration in 0.1 degree increments of either the internal sensor on the ZSM or the remote sensor if used.
18	Baud Rate	0 = 1024 baud 1 = 1200 baud	1	Set to Zero for 3 - 25 Ton Voyager Units built before Jan. 1, 1996 that have the original UCP.
19	CV or HP Operation	0 = CV 1 = HP	0	This sets the operation MODE for the ZSM. If HP is selected, EMERGENCY heat is available.
20	Default Cooling Set Point	45 to 98	74	If no set point has been programmed or the program is lost, the value set here becomes the operation set point.
21	Default Heating Set Point	43 to 96	68	If no set point has been programmed or the program is lost, the value set here becomes the operation set point.
22	Minimum Cooling Set Point	45 to 98	45	Sets the minimum programmable cooling temperature set point.
23	Maximum Heating Set Point	43 to 96	96	Sets the maximum programmable heating temperature set point.

Programming And Operation

Programming Menu

Before entering the Programming Menu, select the MODE of operation using the MODE KEY. If the HEAT or EMER Mode is selected, then only the heating set points can be programmed. If the COOL Mode is selected, then only the Cooling set point can be programmed. If the AUTO or OFF Mode is selected, then both the Heating and Cooling set points can be programmed.

Once you have toggled to the program screen, the week is divided into 7 days and each day is divided into 4 periods. You will have 28 possible program settings. Use the Weekly Programming Record, enter each of the programmed settings for future use. Refer to the Program Menu Screen illustration.

Programming without INTELLIGENT COPY™

1. From the Normal Run State, press the PROGRAM KEY.
2. If desired, all preset-programmed values can be removed by holding the ERASE KEY down for 5 seconds.
3. Press the DAY KEY repeatedly until the desired day of the week is displayed.
4. Press the PROGRAM KEY repeatedly until the desired period (MORN, DAY, EVE, NITE) and desired mode (HEAT and/or COOL) is displayed.

Note: If AUTO was selected in the Normal Run State, pressing the PROGRAM KEY will toggle between the desired period of the day and the Cooling and Heating set points.

5. Use the TIME KEY to set the Start time for the period.
6. Use the UP and DOWN arrows to set the desired operating set points. The ZSM will maintain a 2-degree F (1 degree C) deadband between the Heating and Cooling set points by automatically changing the non-displayed set point stored in memory.
7. Press and hold the UP AND DOWN arrows simultaneously for 2 seconds to toggle between the status of the zone (OCCUPIED AND UNOCCUPIED).
8. Press the FAN KEY to program the fan to be either ON or AUTO for this period.

Note: This feature will not be available if option 10 in the OPTIONS MENU has been set to 0.

9. Pressing the ERASE KEY will erase the Start Time and Desired set points. They can be left blank or re-entered using steps 5 through 8.

Note: When a set point for any of the 4 daily periods are left blank in an OCCUPIED period, the ZSM will control to the last OCCUPIED set point. The same will occur for an UNOCCUPIED period.

10. Press the PROGRAM KEY once to advance to the next period of the day.

If the programming is for the last period of the day, the display will cycle to the first period of the same day. To advance to the next day, press the DAY KEY and repeat steps 5 through 10.

11. Press and hold the PROGRAM KEY for 2 seconds to exit the Programming Menu.

Programming with INTELLIGENT COPY™

INTELLIGENT COPY is a method of quickly programming all or many of the days that will use the same program. To program Monday through Friday, only one week day needs to be programmed. Likewise, to program the weekend, only one weekend day needs programming.

For INTELLIGENT COPY to function;
Option 8 in the OPTIONS MENU must be set to 0 and;
All programmed periods and set points must be erased.

1. From the Normal Run State, press the PROGRAM KEY.
2. Use the DAY KEY to select a weekday.
3. Set the Start Time, the Set Points, and the operating Status of the Zone for each period of the selected day. INTELLIGENT COPY will copy these parameters to the other weekdays.
4. Repeat steps 1 through 4 for a weekend day.
5. Press the DAY KEY to complete the procedure. Press and Hold the PROGRAM KEY for 2 seconds to return to the Normal Run State.
6. Now that all of the parameters are set, by scrolling through each day and the period for that day, changes can be made to the program without affecting other days and periods.

Programming And Operation

Program Menu Screen

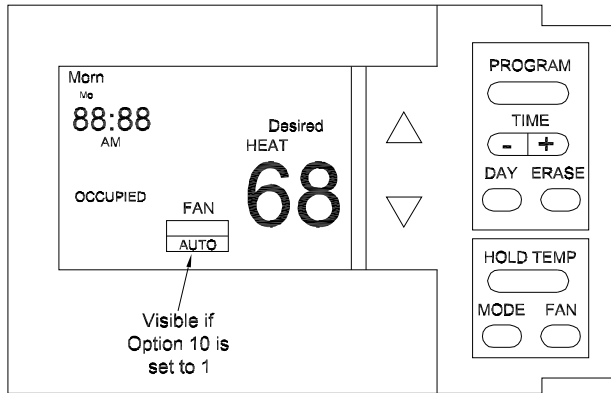

Key Press

Action

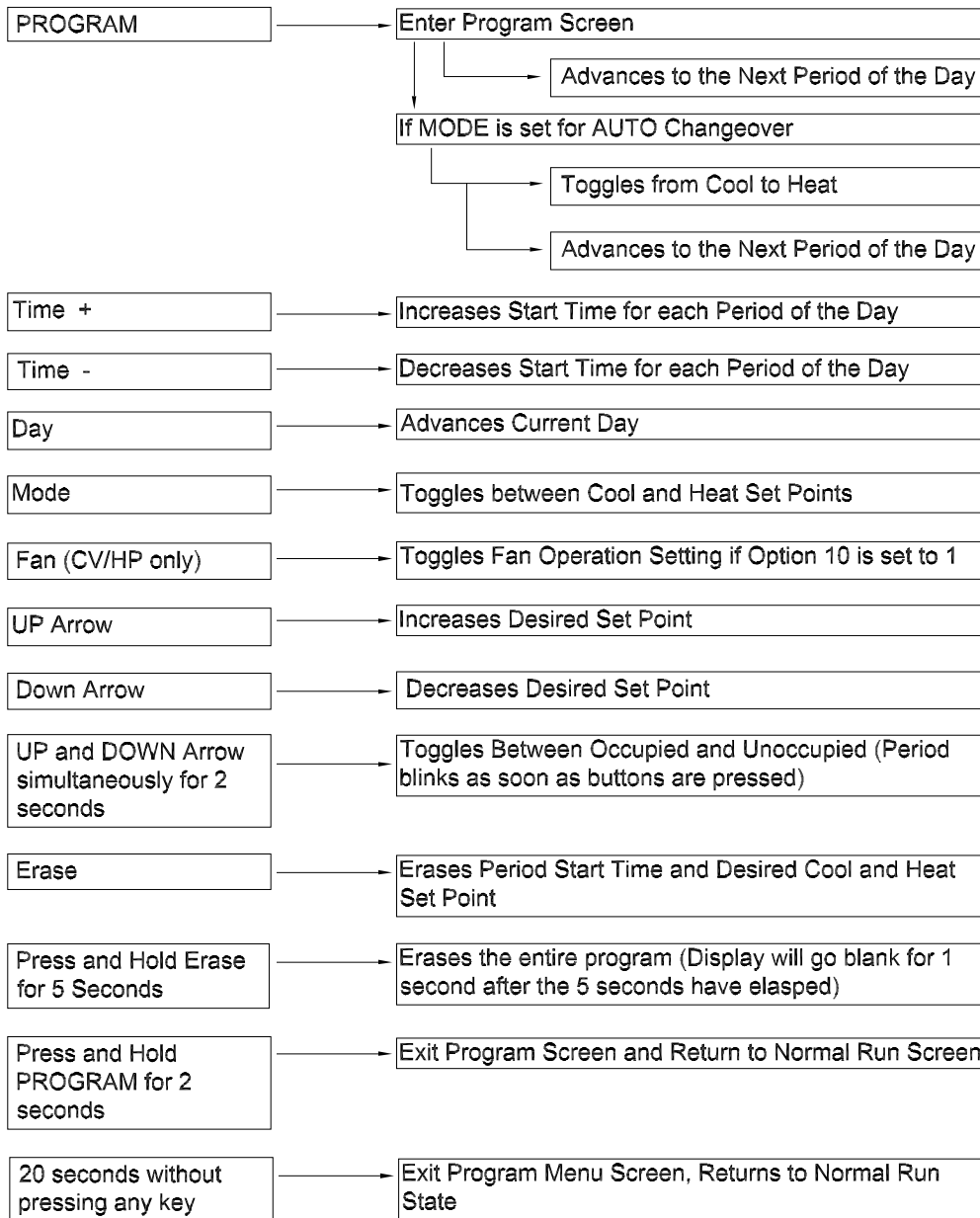

Programming And Operation

Weekly Program Record

Monday					
	Start Time	Heat Set Point	Cool Set Point	Occupied/Unoccupied	
Morn				Occ	/ Unocc
Day				Occ	/ Unocc
Eve				Occ	/ Unocc
Nite				Occ	/ Unocc
Tuesday					
	Start Time	Heat Set Point	Cool Set Point	Occupied/Unoccupied	
Morn				Occ	/ Unocc
Day				Occ	/ Unocc
Eve				Occ	/ Unocc
Nite				Occ	/ Unocc
Wednesday					
	Start Time	Heat Set Point	Cool Set Point	Occupied/Unoccupied	
Morn				Occ	/ Unocc
Day				Occ	/ Unocc
Eve				Occ	/ Unocc
Nite				Occ	/ Unocc
Thursday					
	Start Time	Heat Set Point	Cool Set Point	Occupied/Unoccupied	
Morn				Occ	/ Unocc
Day				Occ	/ Unocc
Eve				Occ	/ Unocc
Nite				Occ	/ Unocc
Friday					
	Start Time	Heat Set Point	Cool Set Point	Occupied/Unoccupied	
Morn				Occ	/ Unocc
Day				Occ	/ Unocc
Eve				Occ	/ Unocc
Nite				Occ	/ Unocc
Saturday					
	Start Time	Heat Set Point	Cool Set Point	Occupied/Unoccupied	
Morn				Occ	/ Unocc
Day				Occ	/ Unocc
Eve				Occ	/ Unocc
Nite				Occ	/ Unocc
Sunday					
	Start Time	Heat Set Point	Cool Set Point	Occupied/Unoccupied	
Morn				Occ	/ Unocc
Day				Occ	/ Unocc
Eve				Occ	/ Unocc
Nite				Occ	/ Unocc

Note: Prior to programming, the Morn and Day periods default to an OCCUPIED status and the Eve and Nite periods default to an UNOCCUPIED status.

Programming And Operation

Temporary Override Menu

The Temporary Override Menu is used to change temperature set points, Mode of Operation, and the Zone status (OCCUPIED or UNOCCUPIED) for a designated length of time without having to change what typically would be the Normal Program. If Option 10 is set to 1, then the Fan Mode will be displayed and programmable. Refer to the Temporary Override Menu screen illustration.

Note: Changing option 9 or 10 will erase the current program setting.

To enter the Temporary Override Menu;
If option 14 in the Options Menu (Keypad Lockout) is enabled and the Lock icon is visible, press and hold the Positive (“+”) and Negative (“-”) side of the TIME KEY simultaneously to unlock the keypad.

1. From the Normal Run State, press the HOLD TEMP KEY or either the UP or DOWN KEY.
2. The HOURS icon located under the right two digits of the clock will be blinking. Press the Positive (“+”) side of the TIME KEY to increase the number of hours the override program will last. Press the Negative (“-”) side of the TIME KEY to decrease the number of hours.
3. Press the DAY KEY to toggle from the Hours icon to the Days icon. Press the Positive (“+”) side of the TIME KEY to increase the number of days the override program will last. Press the Negative (“-”) side of the TIME KEY to decrease the number of days.
4. Press the UP or DOWN arrows to program the temperature set points (HEAT and/or COOL). Use the MODE KEY to toggle between the Modes if applicable.

5. Press the FAN KEY to program the fan for ON or AUTO operation during the override period.
6. Press and hold the UP and DOWN arrows simultaneously for 2 seconds to toggle the zone status between OCCUPIED and UNOCCUPIED.
7. Pressing the ERASE KEY will cancel any override programming and return the sensor to the Normal Run State.
8. Press the HOLD TEMP KEY to confirm the program and to start Temporary Override. If no keys are pressed, the sensor will return to the Normal Run State and ignore the override program.

Entering the Temporary Override Screen

Once the override program has begun and the Keypad Lockout is disabled, the MODE KEY will allow the operator to change the System Mode. The ERASE KEY can only be used to cancel the CHECK FILTER signal if displayed. The FAN KEY will exit the Temporary Override Program and enter the Temporary Override Menu screen. All other keys are disabled. Refer to the Temporary Override screen illustration.

To Exit the Temporary Override program;

1. Press either of the UP or DOWN arrows, the HOLD TEMP KEY, or the FAN KEY. (Returns sensor to the Temporary Override Menu)
2. To change the program parameters, refer to the previous programming steps 2 through 8.
3. To return to the Normal Run State from the Temporary Override Menu, press the ERASE KEY.

Programming And Operation

Temporary Override Menu Screen

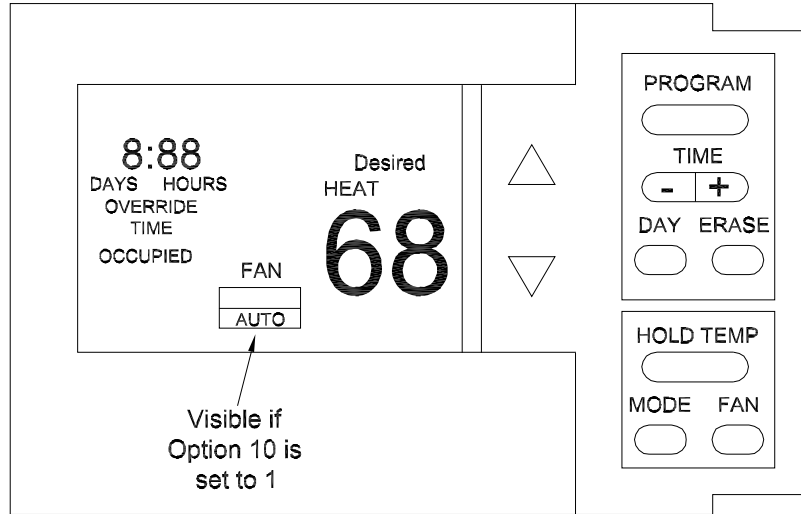

Key Press

Action

Time +	Increases Override Time, Scrolls Rapidly If Held Down
Time -	Decreases Override Time, Scrolls Rapidly If Held Down
Day	Toggles Between Blinking HOURS and DAYS
Hold Temp	Exit Override Menu and Begins Temporary Override Program
Program	
Mode	Toggles between Cool and Heat Set Points
Fan (CV/HP only)	Toggles Fan Operation Setting if Option 10 is set to 1
UP Arrow	Increases Desired Set Point
Down Arrow	Decreases Desired Set Point
UP and DOWN Arrow simultaneously for 2 seconds	Toggles Between Occupied and Unoccupied (Period blinks as soon as buttons are pressed)
Erase	Cancels Override Programming and Returns to Normal Run State
20 seconds without pressing any key	Exit Program Menu Screen, Returns to Normal Run State

Programming And Operation

Override Run State Screen

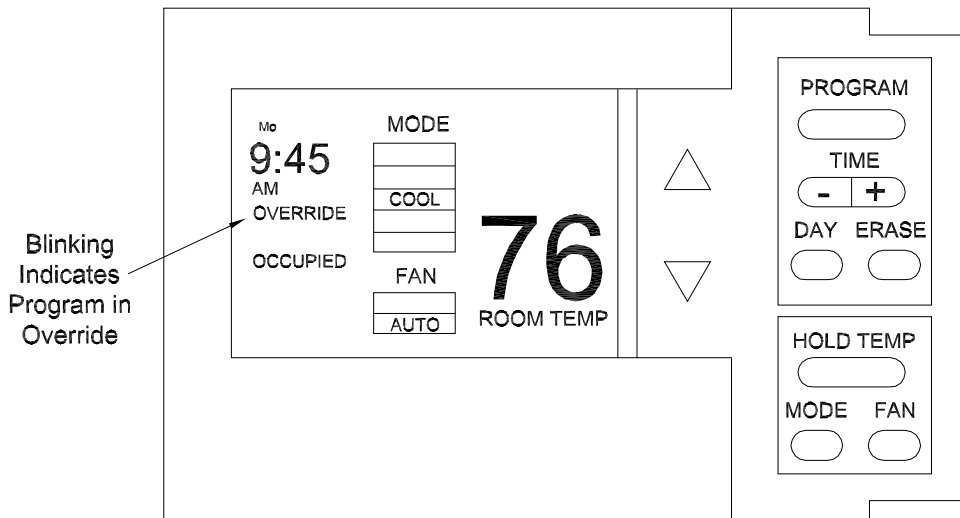

Key Press

Action

Hold Temp	→	Enter Temporary Override Menu
Mode	→	Advances one position for MODE selection
Fan (CV/HP only)	→	Toggles Fan Operation Setting if Option 10 is set to 1
UP Arrow	→	Enter Temporary Override Menu
Down Arrow	→	Enter Temporary Override Menu
Erase	→	Turns off Check Filter Icon, Turns off BEEP until next day when a HEAT FAIL or COOL FAIL Icon is Displayed
Time + and - simultaneously for 4 seconds	→	Toggles Keypad Lockout if Option 14 is set to 1

Troubleshooting

Zone Sensor Status Indicators

The Unit Control Processor (UCP) has the capability of communicating four input signals (HEAT, COOL, ON, SERVICE) to the respective Zone Sensor Module (ZSM) icons when appropriately wired.

Each of these Zone Sensor icons will respond to the UCP in 1 of 3 conditions;

- OFF – No icon will be displayed when the unit is not operating.
- ON – Indicates that the unit is operating in the Mode reflected by the illuminated icon.
- FLASHING – Indicates that the system is not operating properly and some type of service may be required.

The UCP Status Input conditions and the respective zone sensor terminals are;

Terminal # 7 – (HEAT Icon)

- ON – Indicates by a continuously illuminated icon that the unit is operating in the Heating Mode.
- FLASHING – The HEAT FAILURE icon indicates that a system failure in the Heating Mode has occurred.

Terminal # 8 – (COOL Icon)

- ON – Indicates by a continuously illuminated icon that the unit is operating in the Cooling Mode.
- FLASHING – The COOL FAILURE icon indicates that a system failure in the Cooling Mode has occurred.

Terminal # 9 – (ON Icon)

- OFF – The Colon (:) displayed in the Clock is not flashing, the System is OFF.
- ON – The Colon (:) displayed in the Clock is flashing, the System is ON.
- FLASHING – The TEST icon indicates the System is operating in the Test Mode.

Terminal # 10 – (SERVICE Icon)

- ON - Indicates by a continuously illuminated icon that the unit requires service.
- FLASHING – Indicates that a Fan Failure has occurred and service is required.

If number 2 is selected for option 16 in the Options Menu, any of the FLASHING signals will sound an audible buzzer. To reset the buzzer, press the ERASE Key.

Battery Replacement

To replace the battery, depress the metal retainer clip and the battery will spring forward. Refer to the illustration for battery and clip location.

Replace the battery with the same voltage and type stamped on the battery.

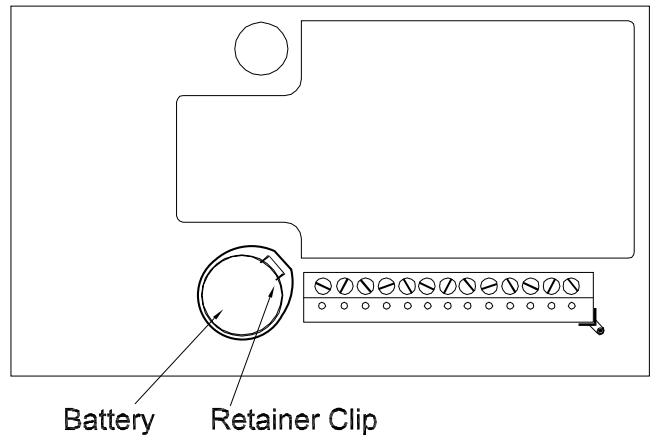

Troubleshooting

Problem	Solution
Display does not come on.	Check the 24 VAC power supply at terminals 11 and 14 at the Zone Sensor. Verify that the terminal block is properly positioned on its pins.
No communications to the UCP.	Check for 22 to 42 VDC between terminals 11 and 12 at the Zone Sensor. Check wiring if no voltage is present.
Display Zone Temperature reads Sh and the COOL FAIL icon is continuously illuminated.	<ol style="list-style-type: none"> 1. Verify that Option 11 in the Options Menu is set correctly. If correct, check the wiring from the remote sensor at terminals S1 and S2 for a shorted condition. 2. If Option 11 in the Options Menu is set to 0, then the local thermistor is selected and the on-board thermistor is shorted and the ZSM must be replaced.
Display Zone Temperature reads oP and the COOL FAIL icon is continuously illuminated.	<ol style="list-style-type: none"> 1. Verify that Option 11 in the Options Menu is set correctly. If correct, check the wiring from the remote sensor at terminals S1 and S2 for an open circuit condition. 2. If Option 11 in the Options Menu is set to 0, then the local thermistor is selected and the on-board thermistor is open and the ZSM must be replaced.
Zone Temperature is not displayed.	Verify that number 1 has been selected for option 13 in the Options Menu.
ZSM keypad does not respond to selection	Verify that the Keypad is not in the Lockout Mode. Press and hold the TIME ("+") and ("-") Key for 4 seconds to unlock the keypad.
The Clock requires reprogramming after short power interruptions.	Replace Battery.
FAN Mode is set in the ON position but the Fan is not running.	Check option 6 in the Options Menu. Refer to the Options Menu section for option description.
System is operating before the programmed start time.	Check option 7 in the Options Menu. Computed recovery option overrides the last part of an unoccupied period to obtain the occupied setting in time.
Buzzer indicates System Failure or Service is required.	Press the ERASE Key to reset the filter lapse timer. Buzzer will be reset until noon of the next day if a System Failure has not been corrected.
Note: To reset the program and initiate a Self Diagnostic Test; press the PROGRAM KEY, HOLD TEMP KEY, and DAY KEY simultaneously.	

